EST2

System Operation Manual

P/N 270188 • REV 07 • REB 27FEB13

DEVELOPED BY

UTC Fire & Security
8985 Town Center Parkway
Bradenton, FL 34202
(941) 739-4200

COPYRIGHT NOTICE

© 2013 UTC Fire & Security. All rights reserved.

This manual is copyrighted by UTC Fire & Security (UTCFS). You may not reproduce, translate, transcribe, or transmit any part of this manual without express, written permission from UTC Fire & Security.

This manual contains proprietary information intended for distribution to authorized persons or companies for the sole purpose of conducting business with UTC Fire & Security. Unauthorized distribution of the information contained in this manual may violate the terms of the distribution agreement.

Content

	Important information • ii
	Document history • iv
	The EST2 library • v
Chapter 1	Introduction • 1
	Using this manual • 2
	Documentation conventions • 4
Chapter 2	Operating panel devices • 7
	Operating the 2-LCD • 9
	Reading 2-LCD messages • 14
	Acknowledging prioritized messages • 16
	Responding to off-normal conditions • 17
	Initiating a drill test • 21
	Checking system status • 22
	Programming system functions • 28
	Enabling system functions • 31
	Disabling system functions • 34
	Activating system functions • 37
	Restoring system functions • 39
	Generating reports • 40
	Testing system functions • 44
	Operating LED/switch modules • 46
	Operating the 2-MIC • 48
	Operating the 2-TEL • 50
	Operating the SIGA-MDM • 51
Chapter 3	Operating remote devices • 53
	Operating remote alphanumeric annunciators • 54
	Reading and operating SAN annunciators • 61
Chapter 4	Operating peripheral devices • 73
	PT-1S Printer • 74
	RSAN-PRT Printer • 76
Appendix A	Operator instructions • 77
	Posting operator instructions • 78
	Index • 81

Important information

Limitation of liability

This product has been designed to meet the requirements of NFPA 72 *National Fire Alarm Code*, UL 864 *Standard for Control Units for Fire Protective Signaling Systems*, and ULC S527 *Standard for Control Units for Fire Alarm Systems*. Installation in accordance with this manual, applicable codes, and the instructions of the authority having jurisdiction is mandatory. UTCFS shall not under any circumstances be liable for any incidental or consequential damages arising from loss of property or other damages or losses owing to the failure of UTCFS products beyond the cost of repair or replacement of any defective products. UTCFS reserves the right to make product improvements and change product specifications at any time.

While every precaution has been taken during the preparation of this manual to ensure the accuracy of its contents, UTCFS assumes no responsibility for errors or omissions.

FCC warning

This equipment can generate and radiate radio frequency energy. If this equipment is not installed in accordance with this manual, it may cause interference to radio communications. This equipment has been tested and found to comply with the limits for Class A computing devices pursuant to Subpart B of Part 15 of the FCC Rules. These rules are designed to provide reasonable protection against such interference when this equipment is operated in a commercial environment. Operation of this equipment is likely to cause interference, in which case the user at his own expense, will be required to take whatever measures may be required to correct the interference.

FCC information

1. The dialer complies with Part 68 of the FCC rules. The Dialer's FCC registration number and the Ringer Equivalence Number (REN) are on the back of the dialer. This information must be provided to the telephone company, if requested.
2. An FCC compliant telephone cord and modular plug cord is supplied with the dialer. The dialer is designed to be connected to the telephone network using the supplied cord and an RJ31X or RJ38X jack, which must also comply with FCC Part 68 rules.

3. The REN is used to determine the quantity of devices which may be connected to the telephone line. Excessive RENs on the telephone line may result in the devices not ringing in response to an incoming call. In most, but not all areas, the sum of RENs should not exceed five (5). To be certain the number of devices that may be connected to a line, as determined by the total RENs, contact the local telephone company.
4. If the dialer causes harm to the telephone network, the telephone company will notify you in advance that temporary discontinuance of service may be required. If advance notice isn't practical, the telephone company will notify you as soon as possible. You will also be advised of your right to file a complaint with the FCC, if you believe it is necessary.
5. The telephone company may make changes in its facilities, equipment, operations, or procedures that could affect the operation of the dialer. If this happens, the telephone company will provide advance notice in order for you to make necessary modifications to maintain uninterrupted service.
6. If trouble is experienced with the dialer, for repair or warranty information, contact:

UTC Fire & Security
8985 Town Center Parkway
Bradenton, Florida, USA 34202
Telephone: 1-800-655-4497

If the dialer is causing harm to the telephone network, the telephone company may request you disconnect the dialer until the problem is resolved.
7. No repairs may be performed on the dialer by the user.
8. The dialer cannot be used on public coin phone or party line service provided by the telephone company.

Document history

Date	Revision	Reason for change
31MAY95	1.0	Initial Release.
01AUG95	2.0	Revised: Drill and test warning notes; Sensitivity Report Output; misc. editorial corrections Added: Maintenance level info; DL2 info
20SEP95	2.5	Revised: Editorial corrections throughout manual; updated autoprogramming.
DEC95	3.0	Added 2-CMDN, SAN, and APSB Power Supply information. Revised: DL2 information.
MAR97	3.5	Added: CDR-3, 2-SMK, 2-CTM, and 2-PPS/6A information. Revised: DL2 information.
SEP97	4.0	Added: paging and telephone operations
OCT97	4.1	Added: 2-LSRA(-C) information; deleted 2-CMDN(-C) information
AUG00	5.0	Added SIGA-MDM information.
25APR05	6.0	Revised: Minor problems found in Rev 5.0; changed NFPA 72 and UL 864 references to show latest revisions; moved document history to the back of the front matter.
22JAN09	6.0	All sections revised to reflect compliance with UL 864, 9th edition.
27FEB13	07	Rebranded for UTC Fire & Security.

The EST2 library

EST2 documents

A library of related documents supports the EST2 product line. Here is a complete list of the EST2 library:

- *EST2 Installation and Service Manual* (P/N 270186)
- *EST2 Network Supplement Manual* (P/N 270894)
- *EST2 System Operation Manual* (P/N 270188)
- *EST2 Installation Sheets* (P/N 3100056)
- *2-SDU Help* (P/N 180902)

Our technical writers constantly update the information in this manual. Your comments during our training classes, technical support phone calls, and field trips improve this document.

Other documents

The *Signature Series Intelligent Smoke and Heat Detectors Applications Bulletin* (P/N 270145) provides instructions and illustrations for various arrays of smoke and heat detectors.

The *Signature Series Component Installation Manual* (P/N 270497) supports the installation of the Signature Series detectors and modules.

The *Serial Number Log Book* (P/N 270267) provides a convenient means for recording the serial number of each Signature device installed in the fire alarm system.

The *SAN Annunciator Installation Guide* (P/N 250084) supports the SAN annunciators mentioned in this manual.

The *Speaker Application Guide* (P/N 85000-0033) provides information about the placement and layout of speakers for fire alarm signaling and emergency voice communications.

The *Strobe Applications Guide* (P/N 85000-0049) provides information for the placement and layout of strobes for fire alarm signaling.

The *Microline Turbo Printer Handbook*, by Okidata provides all the necessary information for the maintenance and configuration of the PT-1S Form Printer. The Okidata handbook comes with the Form Printer.

Chapter 1

Introduction

Summary

Read this chapter to familiarize yourself with the layout and style of the *EST2 System Operation Manual*.

Content

Using this manual • 2

 Chapter overview • 2

 Appendix • 3

Documentation conventions • 4

 Important notices • 4

 System parameters • 4

 Installation and operation procedures • 5

Using this manual

Chapter overview

The *EST2 System Operation Manual* divides the operation of the fire alarm system into three categories:

- Panel devices
- Remote devices
- Peripheral devices

Operating panel devices

The panel devices include modules, which mount inside the fire alarm control panel and provide an operator interface with the system. All of the following operator interface devices mount in the fire alarm control panel:

- 2-LCD
- LED/switch modules
- 2-MIC
- 2-TEL
- SIGA-MDM

The explanation for each device usually includes a picture and one or two tables, which describe the controls and indicators on the device. The 2-LCD, however, provides the detailed messages and an extensive amount of operator control over the system. Therefore, the 2-LCD requires a systematic description of its controls and an explanation of the procedures for using it.

Operating remote devices

Remote devices provide operator interfaces at locations away from the fire alarm control panel. Remote operator interface devices include:

- 2-CMDN(-C)
- 2-LSRA(-C)
- 2-SANCOM
- 2-SMDN(-C)
- SAN-MIC II
- SHO-4
- SLU-16
- SWU-8/3

Again, the explanation for each device usually includes a picture and one or two tables, which describe the controls and indicators on the device. Exceptions include the SWU-8/3 and the SHO-4, because of their toggle switch options.

Operating peripheral devices

The discussion of peripheral devices covers the operational features of two printers: the PT-1S and the RSAN-PRT. This manual provides instructions for loading and advancing paper in the printer to for printing a history report. Take note, however, that the operation of peripheral devices requires an operator interface. Therefore, you will also need to know how to request a history report from the 2-LCD.

Note: See “Generating reports“ on page 40 for more information.

Appendix

The Appendix provides the information and resources you need for posting the required operator instructions at the fire alarm control panel.

Documentation conventions

Important notices

Notices throughout this manual inform the reader of practices and conditions which affect physical safety, occupant safety, equipment performance, and efficient use of time. Notices appear as warnings, cautions, and notes.

Warnings

Warnings are posted when injury or loss of life may occur through the neglect of safe practices and conditions. Here is an example of a warning notice.

WARNING: Testing the system disables the alarm contact. The system will not notify the fire department in the event of a fire alarm condition during a test. See the system administrator for detailed information.

Cautions

Cautions are posted in the manual to prevent damage to the equipment. A typical caution concerns the prevention of electrostatic discharge (ESD).

Caution: Observe static-sensitive handling practices.

Notes

Notes instruct the reader to avoid practices or conditions that can result in wasted time and effort. For example, a download will not work unless the programmer disconnects the printer from the RS-232 port on the Main Controller Module (MCM).

Note: Disconnect the printer when downloading to the MCM.

System parameters

2-LCD keypad entries and fault messages require knowledge of the system parameters.

Keypad entry parameters

To understand the parameters for 2-LCD keypad entries, see “Making keypad entries” on page 12.

Fault message parameters

To understand the parameters for reading fault messages, see “System service procedures” in the *EST2 Installation and Service Manual*.

Installation and operation procedures

The typical procedure will appear in the following format:

To activate an action:

1. At the 2-LCD, press Activate.
2. Enter a level 1, 2, or 3 password.
3. Press 2 to select Action.
4. Enter the number of the action being activated (nnnn).

The word “Enter,” in steps 2 and 4 implies that the operator will press the appropriate numbers and the ENTER key on the 2-LCD keypad. See “Operating panel devices” on page 2 for more information.

Chapter 2

Operating panel devices

Summary

The 2-LCD is the primary operator interface in the EST2 system. In this chapter, you will find instructions for interpreting its messages and indicators. You'll also find instructions for operating its function switches and message review switches. At the end of the chapter are operator instructions for LED/switch modules, the 2-MIC, the 2-TEL, and the SIGA-MDM.

Content

- Operating the 2-LCD • 9
 - Reading status LEDs • 10
 - Operating control switches • 10
 - Scrolling message review switches • 11
 - Making keypad entries • 12
 - Selecting system functions on the 2-LCD • 13
- Reading 2-LCD messages • 14
 - Current time • 14
 - Messages waiting • 14
 - Event type • 14
 - Event time • 15
 - Event address • 15
 - Event message • 15
- Acknowledging prioritized messages • 16
- Responding to off-normal conditions • 17
 - Fire alarms • 17
 - Supervisory points • 17
 - Trouble conditions • 18
 - Monitor points • 19
 - Maintenance message • 19
 - Verification message • 20
- Initiating a drill test • 21
- Checking system status • 22
 - Viewing the general status screen • 22
 - Viewing the loop status screens • 23
 - Viewing the field panel status screen • 24
 - Viewing the Relay/LED status screen • 25

- Viewing disabled device status • 25
- Programming system functions • 28
 - Setting the system date • 28
 - Setting the system time • 28
 - Changing system passwords • 28
 - Programming the communications class • 29
 - Restarting system devices/functions • 30
 - Reconfiguring SLC1 and SLC2 • 30
- Enabling system functions • 31
 - Enabling a zone • 31
 - Enabling a message • 31
 - Enabling a time control • 31
 - Enabling an RS-485 channel • 32
 - Enabling a panel address • 32
 - Enabling an action • 32
 - Enabling a sequence • 32
 - Enabling a laptop computer • 33
 - Enabling the mapping function • 33
- Disabling system functions • 34
 - Disabling a zone • 34
 - Disabling a message • 34
 - Disabling a time control • 34
 - Disabling an RS-485 Channel • 35
 - Disabling a panel address • 35
 - Disabling an action • 35
 - Disabling a sequence • 35
 - Disabling a laptop computer • 36
 - Disabling the mapping function • 36
- Activating system functions • 37
 - Activating an output • 37
 - Activating an action • 37
 - Activating a sequence • 37
 - Activating smoke sensitivity levels • 38
- Restoring system functions • 39
 - Restoring an output • 39
 - Restoring an action • 39
 - Restoring a sequence • 39
- Generating reports • 40
 - Viewing sensitivity reports • 40
 - Printing sensitivity reports • 41
 - Viewing history reports • 42
 - Printing history reports • 43
- Testing system functions • 44
 - Starting the test function • 44
 - Ending the test function • 45
- Operating LED/switch modules • 46
 - Reading front panel LEDs • 46
 - Activating devices at the front panel • 46
 - Restoring devices at the front panel • 46
 - Canceling commands at the front panel • 47
- Operating the 2-MIC • 48
- Operating the 2-TEL • 50
- Operating the SIGA-MDM • 51

Operating the 2-LCD

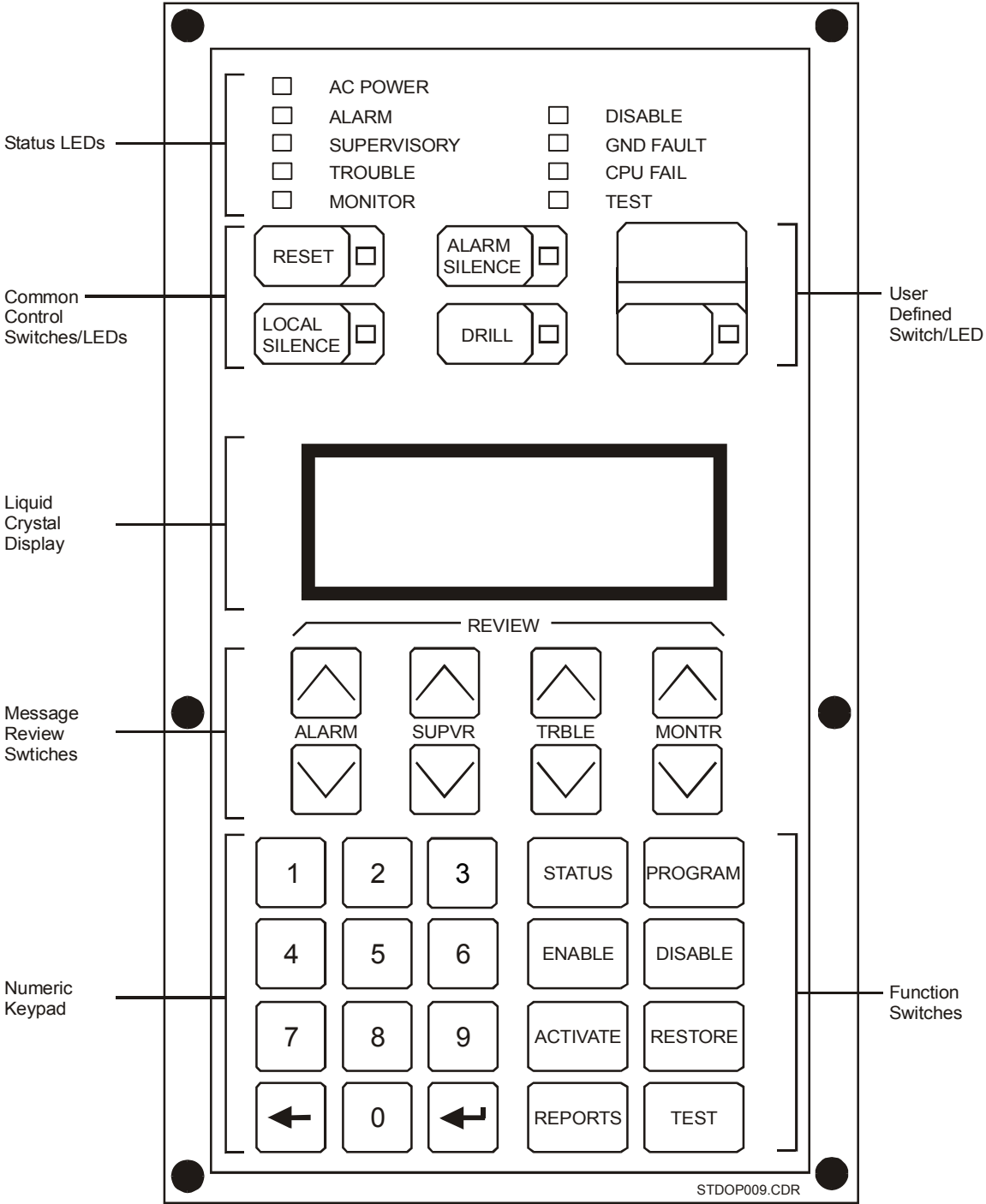

Figure 1: Panel controls and indicators

Reading status LEDs

The 2-LCD contains nine light emitting diodes (LEDs) which indicate the status of the fire alarm control panel.

Table 1: LEDs

LED	Description
AC Power	Indicates mains ac is applied to the panel
Alarm	Indicates an active alarm point in the system
Supervisory	Indicates an active supervisory point
Trouble	Indicates an active trouble condition
Monitor	Indicates an active monitor point
Disable	Indicates one or more zones are disabled
GND Fault	Indicates a ground fault exists
CPU Fail	Indicates a failure in the main controller module
Test	Indicates that the panel is in test mode
User-defined	Site-specific programmed option

Operating control switches

The 2-LCD provides four switches for executing common controls and one user-definable switch.

Table 2: Control switches

Control Switch	Description
Reset	<p>When pressed, the Reset switch returns the panel to normal standby operation. The Reset switch also features an integral LED. When lit, the LED indicates that the panel is resetting. When flashing, the LED indicates that the Reset switch is inhibited.</p> <p>Note: The cause of any off-normal condition must be identified and restored to normal before the panel will reset. Site-specific programming may prevent the operation of this switch for 1 or 3 minutes after the first alarm is received.</p> <p>Reset inhibit (check one): <input type="checkbox"/> none <input type="checkbox"/> 1 minute <input type="checkbox"/> 3 minutes</p>
Local Silence	<p>When pressed, the Local Silence switch quiets the panel buzzer. The Local Silence switch also features an integral LED. When lit, the LED indicates that the panel is in local silence mode.</p> <p>Note: Upon receipt of a new alarm, trouble, or supervisory condition, the controller will exit the local silence mode and resound the panel buzzer.</p>

Table 2: Control switches

Control Switch	Description
Alarm Silence	<p>When pressed, the Alarm Silence switch turns off all audibles or visuals as defined in the 2-SDU. The Alarm Silence switch also features an integral LED. When lit, the LED indicates that the notification appliances are off. When flashing, the LED indicates that the Alarm Silence switch is inhibited.</p> <p>Silence inhibit (check one): <input type="checkbox"/> none <input type="checkbox"/> 1 minute <input type="checkbox"/> 3 minutes</p>
Drill	<p>When pressed, the Drill switch activates all audibles or visuals as defined in the 2-SDU. Drill switch also features an integral LED. When lit, the LED indicates that the Drill mode is on.</p>
User Defined	<p>Site-specific programmed option. This switch will activate:</p> <p>Enter the rule label: <input type="text"/></p> <p>The User-defined switch permits the operator to activate an action by pressing it. The programmer determines the function of the User-defined switch and enters it in the 2-SDU. See the <i>2-SDU Help</i> for details on programming user-defined switch.</p>

Scrolling message review switches



Note: The operator must press the Local Silence switch to review messages on the 2-LCD. Messages are listed with the first (most recent) at the top of the queue and the last (oldest) at the bottom.

Table 3: Message review switches

Message Switch	Description
ALARM	<p>Press the down arrow to scroll from the first alarm message to the last one. Press the up arrow to scroll from last alarm message to the first one. Press both arrows simultaneously to jump to the first message.</p>
SUPVR	<p>Press the down arrow to scroll from the first supervisory message to the last one. Press the up arrow to scroll from last supervisory message to the first one. Press both arrows simultaneously to jump to the first message.</p>
TRBLE	<p>Press the down arrow to scroll from the first trouble message to the last one. Press the up arrow to scroll from last trouble message to the first one. Press both arrows simultaneously to jump to the first message.</p>
MONTR	<p>Press the down arrow to scroll from the first monitor message to the last one. Press the up arrow to scroll from last monitor message to the first one. Press both arrows simultaneously to jump to the first message.</p>

Making keypad entries

Table 4: Keypad entries

Keypad Switch	Description
0 to 9	When pressed, switches 0 to 9 enter the corresponding number or select the corresponding menu item.
	When pressed, the Delete switch deletes the character to the immediate left of the cursor or cancels the menu selection.
	When pressed, the Enter switch causes the panel to process the information shown in the display.

The operator must know the system addresses to make entries on the 2-LCD keypad. System addresses often appear as alphabet characters on the 2-LCD, where:

- pp = panel address (00 through 63)
- zz = zone number

A panel address locates a module or part of a module, either internal or external to the fire alarm control panel. For example, the main controller module (MCM) resides in the control panel and has two panel addresses (01 and 02). The 2-LSRA(-C), however, is a remote annunciator that may have one of several panel addresses (10 through 63).

Note: See “Programming the communications class” on page 29.

A zone number locates a device or function that is either part of a module or wired to it. Zone numbers 01 through 96, on panel addresses 01 and 03, locate Signature series detectors. Zone numbers 03 through 96, on panel addresses 02 and 04, locate Signature series modules. Zone numbers 01 and 02, on panel addresses 02 and 04, locate NACs. Switches, LEDs, and actions may also have zone numbers.

The operator also needs to know parameters for other keypad entries, where:

- yyyy = year
- mm = month
- dd = day
- 01 - 07 = day of week
- hh = hour
- mm = minute
- ss = second
- nnnn = password, action number, sequence number
- tttt = time control
- PP = Priority

Note: Do not confuse a priority (PP) with the panel address (pp).

Selecting system functions on the 2-LCD

Table 5: Function switches

Function Switch	Description
Status	When pressed, the Status switch displays menus for viewing the status of the general panel, the Signature Data Circuit (SDC), relays, LEDs, and disabled devices.
Program	When pressed, the Program switch displays menus for setting the time and date, setting user passwords, configuring the RS-485 port, restarting the system, and autoprogramming.
Enable	When pressed, the Enable switch displays menus for enabling the following system components: zones, zone messages, time controls, data line, panels, actions, sequences, laptop, mapping.
Disable	When pressed, the Disable switch displays menus for disabling the following system components: zones, zone messages, time controls, data line, panels, actions, sequences, laptop, mapping.
Activate	When pressed, the Activate switch displays menus for activating the following system components: output devices, actions, sequences, primary smoke sensitivity levels, and alternate smoke sensitivity levels.
Restore	When pressed, the Restore switch displays menus for returning the following system components to the restored state: output devices, actions, and sequences.
Reports	When pressed, the Reports switch displays menus for obtaining system sensitivity and history reports. Reports may be viewed on the main controller display or sent to a printer.
Test	When pressed, the Test switch activates the walk test function for testing individual initiating device circuits.

Reading 2-LCD messages

Each message on the 2-LCD indicates several details about itself. Figure 2 illustrates a typical fire alarm message.

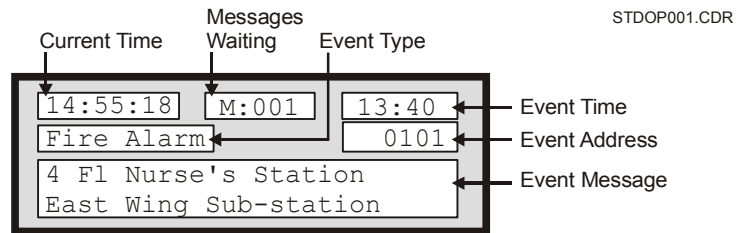

Figure 2: Typical fire alarm message

Current time

The current time appears in twenty-four hour format, and constantly changes to indicate the present system time.

Messages waiting

Messages waiting indicates the number of messages presently in the message queue. The message with the highest priority appears on the 2-LCD while the other messages wait in the queue.

Event type

The 2-LCD displays the following types of event:

- 1st Fire Alarm
- Fire Alarm
- Supervisory
- AC Fault
- Short Fault
- Open Fault
- Comm. Fault
- Ground Fault
- Dev/Line Fault
- Watchdog Fault
- Monitor Act
- PreAlarm Act
- Verification
- Maintenance
- Event
- Disable Flt

Event time

The event time also appears in a twenty-four hour format, but it only indicates the time the event occurred and does not change.

Event address

Each address in the system consists of the following components:

- Panel addresses (01 or 63)
- Zone numbers (01 - 96)

The event address in Figure 2 signifies that the Main Controller Module (MCM) received an alarm condition from a detector at address 01.

Event message

The message below the event address indicates the specific location of the condition and any other relevant information. The programmer customizes the message in the 2-SDU.

See the “System service procedures” chapter in the *EST2 Installation and Service Manual*, for a complete table of system fault messages.

Acknowledging prioritized messages

The 2-LCD has separate queues for each message type, and displays them according to the following priority levels:

- Alarm messages (highest priority)
- Supervisory messages
- Trouble messages
- Monitor messages (lowest priority)

Display	Message queues				Comments
Quiescent State	Alarm	Supervisory	Trouble	Monitor	
13:45:55 AP000 DP000 Project Description					Display shows current time (13:45:55) and no active points.
Monitor Events Received 13:47:56 AP001 DP000 Project Description					An event on Monitor device #234 occurred at 13:47. Nothing is displayed, because the event did not occur during an alarm. On the other hand, the AP counter increases by the number of events.
Fire Alarm Received 13:51:00 M:004 13:51 1st Fire Alarm 0126 5 floor elevator Lobby smoke detector	0126			0235 0236 0237	A fire alarm on device #0126 occurred at 13:51, followed by 3 monitor events: 0235, 0236, and 0237. The alarm message is immediately displayed, and the Message Waiting counter increments to 004.
Fire Alarm Acknowledged 13:54:12 AP004 DP000 Project Description	0126			0235 0236 0237	The fire alarm on device #0126 was reviewed using the ALARM <input checked="" type="checkbox"/> switch.
Monitor Event Acknowledged 13:57:12 M:004 13:51 Monitor Alrm 0235 High temperature on chiller A27	0126			0235 0236 0237	The MONTR <input checked="" type="checkbox"/> switch displays the first monitor event message.
Trouble Event Received 14:03:33 M:005 13:57 Open fault 0288 1 floor Laboratory	0126		0288	0235 0236 0237	A trouble on device #0288 occurred at 13:57. The trouble message replaces the monitor messages on the display, because it has a higher priority. The Message Waiting counter incremented to 005.
Monitor Events Acknowledged 14:05:55 AP005 DP000 Project Description	0126		0288	0235 0236 0237	The monitor events on devices 0236 and 0237 were reviewed in order, using the MONTR <input checked="" type="checkbox"/> switch.
Trouble Event Acknowledged 14:05:55 AP005 DP000 Project Description	0126		0288	0235 0236 0237	The trouble on device #0208 was reviewed using the TRBLE <input checked="" type="checkbox"/> switch.

STDOP043.CDR

Figure 3: Message priorities

Responding to off-normal conditions

During off-normal conditions, the 2-LCD sounds its internal buzzer and displays a message to indicate a problem in the system. You must press the Local Silence switch before you can view messages other than the one displayed during the off-normal condition. Once you press Local Silence, you may view any message in any order by pressing the message review switches.

Fire alarms

Smoke detectors, heat detectors, fire alarm stations, and sprinkler systems may initiate fire alarms. The Alarm LED, when on, indicates a fire alarm.

To respond to a fire alarm:

1. Press the Local Silence switch to silence the buzzer.
2. Read the display to determine the location of the fire alarm condition.
3. Press the Alarm Review switch to view the alarm message(s).

The Alarm Review switch will display any additional alarm locations. Before you can reset the panel, the appropriate personnel must:

- Put out the fire
- Investigate the cause of the fire
- Declare the building safe for re-entry

To reset the panel after a fire alarm:

1. Press the Alarm Silence switch to silence the audible notification appliances.
2. Press the Local Silence switch to silence the buzzer.
3. Press the Reset switch to restore the panel to normal.

If either the Alarm Silence LED or Reset LED flashes, wait until the inhibit period ends, then press the appropriate switch again. The maximum inhibit period is three minutes.

Supervisory points

Active supervisory points indicate that a fire protection system other than the fire alarm panel is off-normal. Conditions like closed sprinkler valves and disabled supplementary fire

extinguishing systems may cause supervisory conditions. The Supervisory LED, when lit, indicates a supervisory condition.

To respond to a supervisory condition:

1. Read the display to determine the location of the supervisory condition.
2. Press the Local Silence switch to silence the buzzer.
3. Press the SUPVR switch to review the supervisory condition messages.
4. Investigate the cause of the supervisory condition.
5. Press the Reset switch to restore the panel to normal.

The supervisory condition must be corrected before the panel will reset. Latching circuits require a manual reset. Nonlatching circuits automatically reset. The 2-LCD display will indicate any additional supervisory conditions. The most recent location appears at the top of the list.

Trouble conditions

Active trouble conditions indicate that some portion of the fire alarm panel is in an off-normal condition, and may affect its proper operation. The Trouble LED, when lit, indicates a trouble condition.

To respond to a trouble condition:

1. Read the display to determine the location of the trouble condition.
2. Press the Local Silence switch to silence the buzzer.
3. Press the TRBLE switch to review the supervisory condition messages.
4. Investigate the cause of the trouble condition.
5. Call for service if you cannot immediately determine the cause of the trouble condition.
6. Press the Reset switch to restore the system to normal.

The panel will not reset until the trouble is repaired. The 2-LCD display will indicate any additional trouble locations. The Trouble LED lights steady when you have acknowledged all the trouble messages.

Monitor points

Active monitor points indicate off-normal conditions in equipment monitored by the fire alarm panel. A typical cause for an active monitor point might be a signal, which indicates the status of the fan systems. The Monitor LED, when on, indicates an active monitor point. In the alarm mode, the 2-LCD will also display active monitor messages.

To respond to a monitor point:

1. Read the display to determine the location of the monitor condition.
2. Press the Local Silence switch to silence the buzzer.
3. Read the monitor point message by pressing the MONTR switch.
4. Investigate the cause of the monitor point.
5. Call for service if you cannot immediately determine the cause of the monitor point.
6. Press the Reset switch to restore the system to normal.

The panel will not reset until the monitor point condition is corrected. The 2-LCD display will indicate any additional monitor point messages. The Monitor LED will light steady when you have acknowledged all the monitor point messages.

The 2-LCD displays monitor points *only* during alarm conditions.

Maintenance message

The 2-LCD will display a maintenance message and sound the buzzer to indicate a maintenance condition. For example, a dirty detector may cause a maintenance condition. The display will annunciate the device address and any programmed message assigned to that device.

To respond to a maintenance message:

1. Press the Local Silence switch to silence the buzzer.
2. Press the MONTR switch to view the maintenance message.
3. Investigate the device indicating the maintenance message.
4. Clean the device.

You can view the maintenance messages on the 2-LCD sensitivity report or a printout.

Verification message

The 2-LCD will display a verification message and sound the buzzer to indicate a verification condition. The display will indicate the device address and any programmed message(s).

To respond to a verification message:

1. Press the Local Silence switch to silence the internal buzzer.
2. Press the MONTR switch to view the verification message.
3. Investigate the cause of the verification condition.

If the device indicating the verification or any other device detects smoke within the specified period of time, both devices will go into alarm and send a message to the display.

Initiating a drill test

The drill function operates all building fire alarm signals as programmed.

To initiate a fire drill:

1. Inform the building occupants that you will be performing a drill.
2. Press the DRILL switch.
3. Press the DRILL switch again to end the drill.

Checking system status

This section explains the functions of the Status switch. In the Status mode, the 2-LCD displays the following screens:

- General Status
- Loop 1 Status
- Loop 2 Status
- Field Panel Status (if conditions exist)
- Relay/LED Status (if conditions exist)
- Disabled Components/Functions (if conditions exist)

Note: For a detailed explanation about the parameters of keypad entries, see *Making keypad entries*, earlier in this chapter.

To access the system status menu:

1. At the 2-LCD, press Status.
2. Enter a level 1, 2, or 3 password.
3. Make the appropriate selection based on the screen in Figure 4.

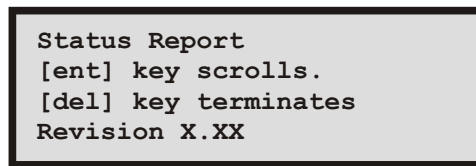

STDOP021.CDR

Figure 4: System status menu

Viewing the general status screen

To view the general status screen:

1. At the 2-LCD, press Status.
2. Enter a level 1, 2, or 3 password.
3. Press Enter until you see the general status screen (Figure 5).

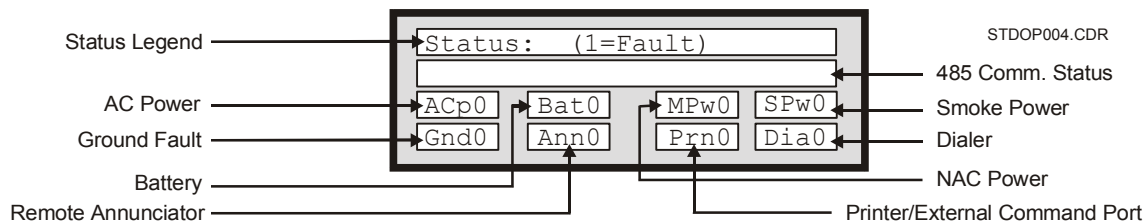

STDOP004.CDR

Figure 5: General status screen

“0” indicates a normal condition for the associated parameter;
 “1” indicates a fault.

Table 6: General status legend

Legend	Cause
ACp	AC Power
Gnd	Ground Fault
Bat	Battery
Ann	Remote Annunciator
MPw	NAC Power
Prn	Printer
Spw	Smoke Power
Dia	Dialer

Viewing the loop status screens

To view the loop status screens:

1. At the 2-LCD, press Status.
2. Enter a level 1, 2, or 3 password.
3. Press Enter until you see the loop 1 status screen (Figure 6).
4. Press Enter one more time to see the loop 2 status screen.

The loop 2 status screen displays the same items as the loop 1 status window.

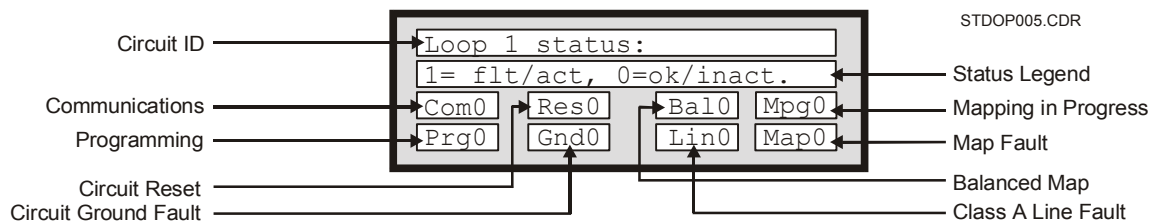

Figure 6: Loop status screen

“0” indicates a normal condition for the associated parameter;
 “1” indicates a fault.

Table 7: Loop status legend

Legend	Cause
Com	Communications fault between loop electronics and main controller module (MCM)
Res	Signature Data Circuit (SDC) is resetting
Bal	SDC is balanced
Mpg	SDC is actively mapping
Prg	Writing to Signature memory
Gnd	Ground Fault on SDC
Lin	Class A Fault on SDC
Map	Map Fault on SDC

Viewing the field panel status screen

If a panel has connections to annunciators or audio equipment, the 2-LCD status function will feature the Field Panel status screen. The Field Panel Status screen indicates the condition of a panel's communications to the annunciators or audio equipment connected to it.

To view the field panel status screen:

1. At the 2-LCD, press Status.
2. Enter a level 1, 2, or 3 password.
3. Press Enter until you see the field panel status screen (Figure 7).

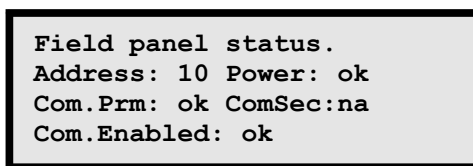

STDOP022.CDR

Figure 7: Typical field panel status screen

Table 8: Field panel status legend

Legend	Cause
Com.Prm	Primary Communications
ComSec	Secondary Communications
Com.Enabled	Communications Enabled

Viewing the Relay/LED status screen

If the system activates a relay or LED, the 2-LCD status function will feature the Relay/LED status screen.

To view the Relay/LED status screen:

1. At the 2-LCD, press Status.
2. Enter a level 1, 2, or 3 password.
3. Press Enter until you see the Relay/LED status screen (Figure 8).

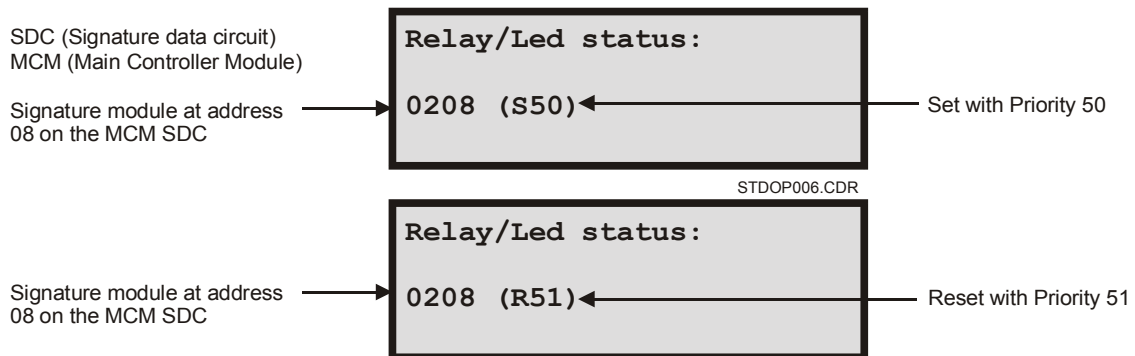

Figure 8: Typical LED/relay status screens

Viewing disabled device status

If the operator disables a device or function of the system, the 2-LCD status function will generate a status screen to show it. Status screens will show the following disabled components or functions:

- Points
- Messages
- Actions
- Time Controls
- Sequences

To view the disabled status screens:

1. At the 2-LCD, press Status.
2. Enter a level 1, 2, or 3 password.
3. Press Enter until you see the disabled status screen (Figure 9 through Figure 13).

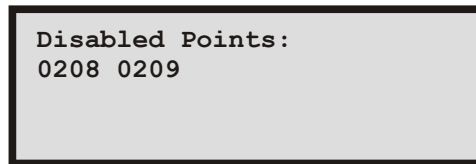

STDOP023.CDR

Figure 9: Typical disabled points screen

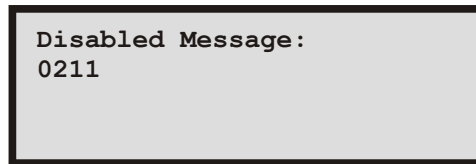

STDOP024.CDR

Figure 10: Typical disabled message screen

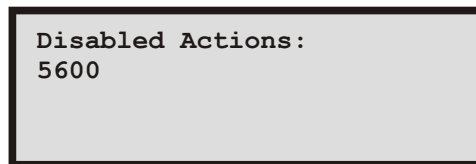

STDOP025.CDR

Figure 11: Typical disabled actions screen

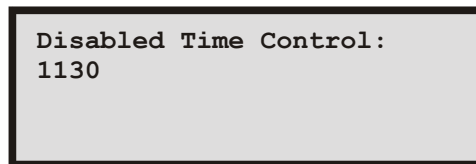

STDOP026.CDR

Figure 12: Typical disabled time control screen

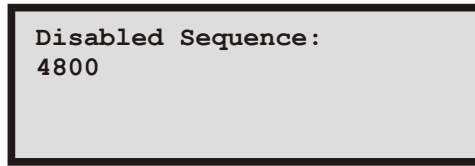

STDOP027.CDR

Figure 13: Typical disabled sequence screen

Programming system functions

This section explains the functions of the Program switch. In the Program mode, the 2-LCD offers the following menu options:

- Date
- Time
- Password
- RS-485 Port Communications
- System Restart
- Reconfigure (Autoprogram)

Note: For a detailed explanation about the parameters of keypad entries, see “Making keypad entries” on page 12.

Setting the system date

To set the system date:

1. At the 2-LCD, press Program.
2. Press 1 to select Date.
3. Enter a level 3 password.
4. Enter the year (yyyy).
5. Enter the month (mm).
6. Enter the day (dd).
7. Enter the day of the week (Sun=01).

Setting the system time

To set the system time:

1. At the 2-LCD, press Program.
2. Press 2 to select Time.
3. Enter a level 3 password.
4. Enter the time (hhmmss).

Changing system passwords

To change a system password:

1. At the 2-LCD, press Program.
2. Press 3 to select Password.
3. Enter a level 3 password.

4. Change the password level (1, 2, or 3).
5. Enter the new password (nnnn).

Table 9: System passwords

Level	Personnel	Default	Access Privileges
1	Operators	1111	All Status, Activate, Restore, and Reports functions
2	Supervisors	2222	All Level 1 privileges and all Enable, Disable, and Test functions
3	Administrators	3333	All Level 1 and 2 privileges and all program functions.

Note: The system installer should change all passwords after the system has been installed.

Programming the communications class

The fire alarm control panel receives the 64 panel addresses listed below:

- 00: Primary power supply
- 01: MCM Signature detectors
- 02: MCM NACs and Signature modules
- 03: LCX Signature detectors
- 04: LCX NACs and Signature modules
- 05: Front panel LED/switch modules
- 06 through 09: Future use
- 10 through 63: Devices and accessories

To program a panel for Class A (Style 7) communications:

1. At the 2-LCD, press Program.
2. Press 4 to select communications class.
3. Enter a level 3 password.
4. Enter the panel address (pp).
5. Enter 1 to program the panel as a Class A (Style 7) circuit.

To program a panel for Class B (Style 4) communications:

1. At the 2-LCD, press Program.
2. Press 4 to select communications class.
3. Enter a level 3 password.
4. Enter the panel address (pp).
5. Enter 2 to program the panel as a Class B (Style 6) circuit.

Restarting system devices/functions

In the Restart menu, you can restart the:

- CPU
- SLCs
- History report

To restart a system device or function:

1. At the 2-LCD, press Program.
2. Press 5 to select Restart.
3. Enter a level 2 or 3 password.
4. Enter the number for the item you want to restart.

Reconfiguring SLC1 and SLC2

To reconfigure the SLCs:

1. At the 2-LCD, press Program.
2. Press 6 to select Reconfig.
3. Enter a level 2 or 3 password.
4. Press Enter to accept the settings and Delete to exit the sequence.

Enabling system functions

This section explains the functions of the Enable switch. In the Enable mode, the 2-LCD offers the following menu options:

- Zones
- Messages
- Time Controls
- RS-485 Channels
- Panels
- Actions
- Sequences
- Laptop Computer Downloading
- Mapping

Note: For a detailed explanation about the parameters of keypad entries, see *Making keypad entries*, earlier in this chapter.

Enabling a zone

To enable a zone:

1. At the 2-LCD, press Enable.
2. Enter a level 2 or 3 password.
3. Enter 1 to select zone.
4. Enter the device address (ppzz).

Enabling a message

To enable a message:

1. At the 2-LCD, press Enable.
2. Enter a level 2 or 3 password.
3. Enter 2 to select message.
4. Enter the device address (ppzz).

Enabling a time control

Note: Do not enable more than 127 time controls at a time.

To enable a time control:

1. At the 2-LCD, press Enable.
2. Enter a level 2 or 3 password.
3. Enter 3 to select time control.

4. Enter the time-control numbers (tttt).

Enabling an RS-485 channel

To enable RS-485 communications on channel 0:

1. At the 2-LCD, press Enable.
2. Enter a level 2 or 3 password.
3. Enter 4 to select RS-485 communications channels.
4. Enter 0 to enable channel 0.

To enable RS-485 communications on channel 1:

1. At the 2-LCD, press Enable.
2. Enter a level 2 or 3 password.
3. Enter 4 to select RS-485 communications channels.
4. Enter 1 to enable channel 1.

Enabling a panel address

To enable a panel:

1. At the 2-LCD, press Enable.
2. Enter a level 2 or 3 password.
3. Enter 5 to select panel.
4. Enter the panel address (pp).

Enabling an action

To enable an action:

1. At the 2-LCD, press Enable.
2. Enter a level 2 or 3 password.
3. Enter 6 to select action.
4. Enter the action number (nnnn).

Enabling a sequence

To enable a sequence:

1. At the 2-LCD, press Enable.

2. Enter a level 2 or 3 password.
3. Enter 7 to select sequence.
4. Enter the sequence number (nnnn).

Enabling a laptop computer

To enable a laptop computer:

1. At the 2-LCD, press Enable.
2. Enter a level 2 or 3 password.
3. Enter 8 to enable the laptop.

Enabling the mapping function

To enable mapping:

1. At the 2-LCD, press Enable.
2. Enter a level 2 or 3 password.
3. Enter 9 to enable mapping.

Disabling system functions

This section explains the functions of the Disable switch. In the Disable mode, the 2-LCD offers the following menu options:

- Zones
- Messages
- Time Controls
- RS-485 Channels
- Panels
- Actions
- Sequences
- Laptop Computer Downloading
- Mapping

Note: For a detailed explanation about the parameters of keypad entries, see “Making keypad entries” on page 12.

Disabling a zone

To disable a zone:

1. At the 2-LCD, press Disable.
2. Enter a level 2, or 3 password.
3. Enter 1 to select zone.
4. Enter the device address (ppzz).

Disabling a message

To disable a message:

1. At the 2-LCD, press Disable.
2. Enter a level 2, or 3 password.
3. Enter 2 to select message.
4. Enter the device address (ppzz).

Disabling a time control

To disable a time control:

1. At the 2-LCD, press Disable.
2. Enter a level 2, or 3 password.
3. Enter 3 to select time control.
4. Enter the time control number (tttt).

Disabling an RS-485 Channel

To disable RS-485 communications on channel 0:

1. At the 2-LCD, press Disable.
2. Enter a level 2, or 3 password.
3. Enter 4 to select RS-485 communications channels.
4. Enter 0 to disable the channel 0.

To disable RS-485 communications on channel 1:

1. At the 2-LCD, press Disable.
2. Enter a level 2, or 3 password.
3. Enter 4 to select RS-485 communications channels (data line).
4. Enter 1 to disable the channel 1.

Disabling a panel address

To disable a panel:

1. At the 2-LCD, press Disable.
2. Enter a level 2, or 3 password.
3. Enter 5 to select panel.
4. Enter the panel address (pp).

Disabling an action

To disable an action:

1. At the 2-LCD, press Disable.
2. Enter a level 2, or 3 password.
3. Enter 6 to select action.
4. Enter the action number (nnnn).

Disabling a sequence

To disable a sequence:

1. At the 2-LCD, press Disable.
2. Enter a level 2, or 3 password.

3. Enter 7 to select sequence.
4. Enter the sequence number (nnnn).

Disabling a laptop computer

To disable a laptop computer:

1. At the 2-LCD, press Disable.
2. Enter a level 2, or 3 password.
3. Enter 8 to select laptop.

Disabling the mapping function

To disable mapping:

1. At the 2-LCD, press Disable.
2. Enter a level 2, or 3 password.
3. Enter 9 to select mapping.

Activating system functions

This section explains the functions of the Activate switch. In the Activate mode, the 2-LCD offers the following menu options:

- Outputs
- Actions
- Sequences
- Primary Smoke Sensitivity
- Alternate Smoke Sensitivity

Note: For a detailed explanation about the parameters of keypad entries, see "Making keypad entries" on page 12.

Activating an output

To activate an output:

1. At the 2-LCD, press Activate.
2. Enter a level 1, 2, or 3 password.
3. Press 1 to select Output.
4. Enter the priority and address for the output device being activated (PPppzz).

Activating an action

To activate an action:

1. At the 2-LCD, press Activate.
2. Enter a level 1, 2, or 3 password.
3. Press 2 to select Action.
4. Enter the number of the action being activated (nnnn).

Activating a sequence

To activate a sequence:

1. At the 2-LCD, press Activate.
2. Enter a level 1, 2, or 3 password.
3. Press 3 to select Sequence.
4. Enter the number of the sequence being activated (nnnn).

Activating smoke sensitivity levels

To activate the primary smoke sensitivity level:

1. At the 2-LCD, press Activate.
2. Enter a level 1, 2, or 3 password.
3. Press 4 to activate the primary smoke sensitivity level.

To activate the alternate smoke sensitivity level:

1. At the 2-LCD, press Activate.
2. Enter a level 1, 2, or 3 password.
3. Press 5 to activate the alternate smoke sensitivity level.

Restoring system functions

This section explains the functions of the Restore switch. In the Restore mode, the 2-LCD offers the following menu options:

- Outputs
- Actions
- Sequences

Note: For a detailed explanation about the parameters of keypad entries, see "Making keypad entries" on page 12.

Restoring an output

To restore an output:

1. At the 2-LCD, press Restore.
2. Enter a level 1, 2, or 3 password.
3. Press 1 to select Output.
4. Enter the priority and address for the output device being restored (PPppzz).

Restoring an action

To restore an action:

1. At the 2-LCD, press Restore.
2. Enter a level 1, 2, or 3 password.
3. Press 2 to select Action.
4. Enter the number of the action being restored (nnnn).

Restoring a sequence

To restore a sequence:

1. At the 2-LCD, press Restore.
2. Enter a level 1, 2, or 3 password.
3. Press 3 to select Sequence.
4. Enter the number of the sequence being restored (nnnn).

Generating reports

This section explains the functions of the Reports switch. In the Reports mode, the 2-LCD offers two report options: sensitivity and history. Both reports may be sent to either the 2-LCD display or a printer.

Note: For a detailed explanation about the parameters of keypad entries, see *Making keypad entries*, earlier in this chapter.

Viewing sensitivity reports

To view a sensitivity report:

1. At the 2-LCD, press Reports.
2. Enter a level 1, 2, or 3 password.
3. Enter 1 to choose a sensitivity report.
4. Enter 1 to send the report to the 2-LCD display.
5. Follow the instructions on the screen illustrated in Figure 14.

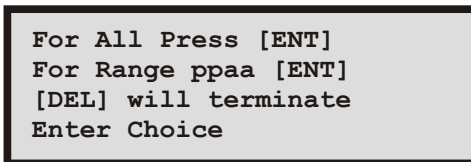

```
For All Press [ENT]
For Range ppaa [ENT]
[DEL] will terminate
Enter Choice
```

STDOP028.CDR

Figure 14: Sensitivity report instructions

Note: If the fire alarm control panel has been on for less than 15 minutes, the 2-LCD will display the screen in Figure 15.

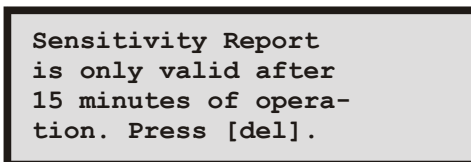

```
Sensitivity Report
is only valid after
15 minutes of opera-
tion. Press [del].
```

STDOP045.CDR

Figure 15: Sensitivity report delay

The parameters “ppaa” stand for the panel and device address. For example, a detector at address 56 on an MCM Signature data circuit would require 0156 for its entry.

Figure 16 illustrates a typical sensitivity report on the 2-LCD.

```

Press [ENT] for more
Add: 0101 Type 3D
Alarm Level: 3%
Maint. Level: 00%

```

STDOP029.CDR

Figure 16: Typical sensitivity report on 2-LCD

Printing sensitivity reports

To print a sensitivity report:

1. At the 2-LCD, press Reports.
2. Enter a level 1, 2, or 3 password.
3. Enter 1 to choose a sensitivity report.
4. Enter 2 to send the report to the printer.
5. Enter the device address of the desired report only on local reports.

Figure 17 illustrates the typical printed format of a sensitivity report.

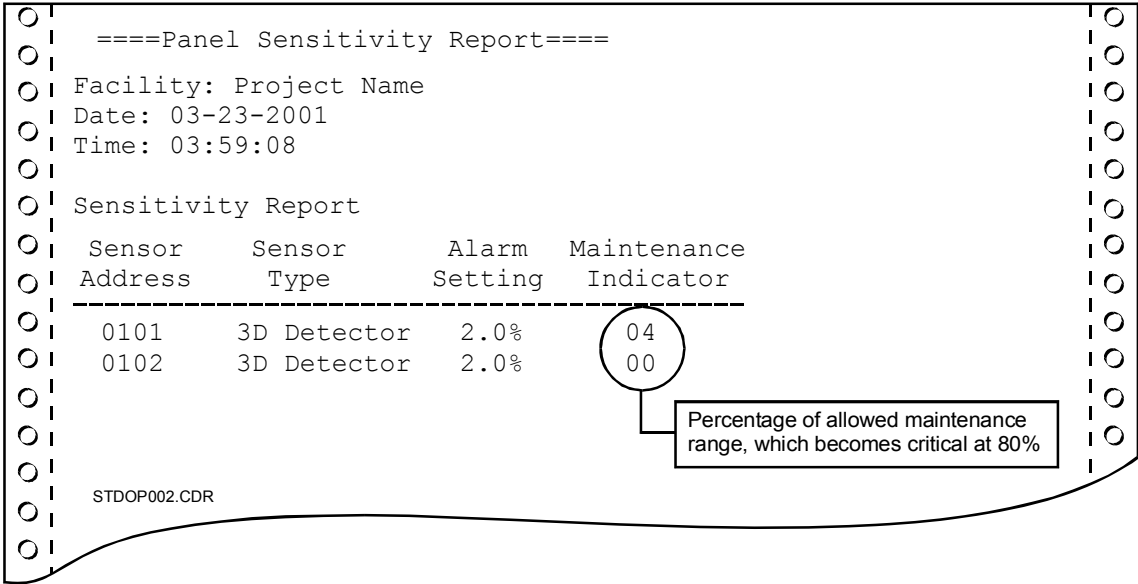

Figure 17: Typical sensitivity report print format

Viewing history reports

To view a history report:

1. At the 2-LCD, press Reports.
2. Enter a level 1, 2, or 3 password.
3. Enter 2 to choose a history report.
4. Enter 1 to send the report to the 2-LCD display.

The 2-LCD will display the screens in Figure 18 and Figure 19.

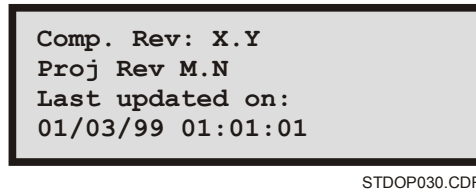

STDOP030.CDR

Figure 18: History report revision

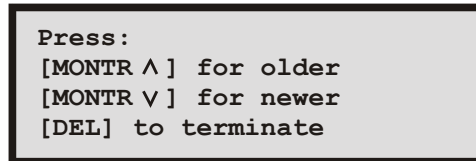

STDOP031.CDR

Figure 19: History report instructions

Figure 20 illustrates two typical history reports on the 2-LCD.

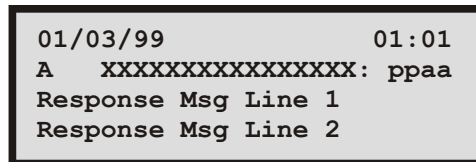

A: Active

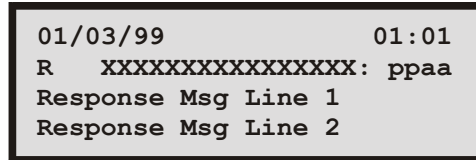

R: Restore

STDOP032.CDR

Figure 20: Typical history reports on the 2-LCD

Printing history reports

Note: A History Report will contain the last 650 events.

To print a history report:

1. At the 2-LCD, press Reports.
2. Enter a level 1, 2, or 3 password.
3. Enter 2 to choose a history report.
4. Enter 2 to send the report to the printer.

Figure 21 illustrates the typical printed format of a history report.

```

==== System History Report ====
Facility Name: Medical Arts Center

Licensee: 00114-P. Smith
Compiled on 10/31/99 22:16:53
Compiler Rev: 01.03.0
Project Rev: 14.6
Report Date: 10-31-1999
and Time: 23:30:20

ACTIVATION 1st Fire Alarm: 0301 Date: 10/31/99 Time 01:01
                SMOKE DETECTOR #1
ACTIVATION Fire Alarm: 0302 Date: 10/31/99 Time 01:03
                SMOKE DETECTOR #2
ACTIVATION Switch: 0535 Date: 10/31/99 Time: 01:09
                FAN ON
Restoration Switch: 0535 Date: 10/31/99 Time 01:11
ACTIVATION Relay/Output: 0221 Date:)10/31/99 Time: 16:11
                CC2 LOOP 1
                STDOP003.CDR
  
```

Figure 21: Typical history report print format

Testing system functions

WARNING: Testing the system disables the alarm contact. The system will not notify the fire department in the event of a fire alarm condition during a test. See the system administrator for detailed information.

This section explains the functions of the Test switch. The Test switch temporarily disables normal system responses during the testing of panels, detectors, and modules. The 2-LCD and the printer report all responses from activated devices and devices with trouble conditions.

The system programmer sets the test function for silent or audible operation in the system definition utility (2-SDU). In silent operation, the device under test will not activate Notification Appliance Circuits (NACs). In audible operation, the device under test activates programmed NACs for approximately 2 seconds. The system programmer may also program *test only* functions.

Starting the test function

For a detailed explanation about the parameters of keypad entries, see *Making keypad entries*, earlier in this chapter.

Note: The buzzer will sound when you have successfully entered the test mode. Press Local Silence to silence the buzzer.

To start the Test function:

1. At the 2-LCD, press Test.
2. Enter a level 2 or 3 password.
3. Follow the instructions on the test screen (Figure 22).

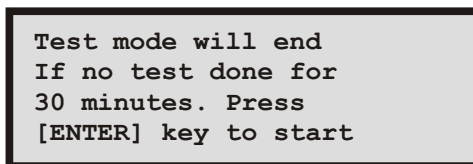

```
Test mode will end
If no test done for
30 minutes. Press
[ENTER] key to start
```

STDOP033.CDR

Figure 22: Test screen

Figure 23 illustrates the 2-LCD display during the test mode.

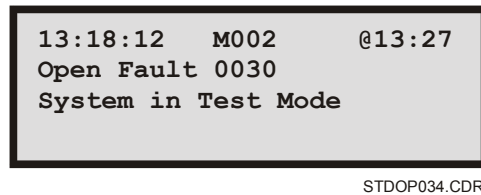

STDOP034.CDR

Figure 23: Typical test mode screen

Ending the test function

The Test function ends through operator input or automatic system response and resets the fire alarm control panel.

To end the Test function manually:

1. At the 2-LCD, press Test.
2. Press Delete.

The test function will automatically end if you let 30 minutes pass without testing a device. The 2-LCD provides a reminder of the 30-minute test window, as seen in Figure 22.

See the site-specific information, provided with the panel, for customized test functions.

Operating LED/switch modules

The front panel LED/switch modules provide manual control to various portions of the system. The operator may view LEDs to determine the status of a device, or press an associated switch pad to change its state. During any change of state, the LEDs flash through a duty cycle. All commands may be cancelled by pressing the switch pad a second time before the command is executed.

Reading front panel LEDs

Each switch has two LEDs. A flashing sequence on the upper LED indicates the activation or restoration of a device. The lower LED operates independently, but it usually indicates the status of a function related to the switch pad.

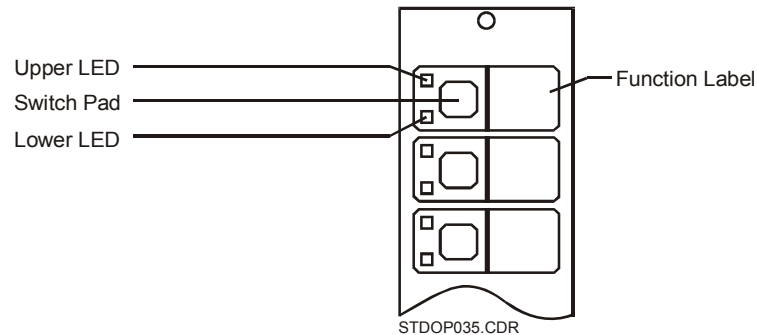

Figure 24: Front panel LED/switch module

Activating devices at the front panel

To activate a device, press its corresponding switch. The upper LED will flash with a 10% duty cycle as shown in Figure 25 (top). During the 10% duty cycle, the LED is off more than it is on. The LED stops flashing and remains lit when the device is fully activated.

Restoring devices at the front panel

To restore a device, press its corresponding switch. The upper LED will flash with a 90% duty cycle as shown in Figure 25 (bottom). During the 90% duty cycle, the LED is on more than it is off. The LED turns off completely when the device is fully restored.

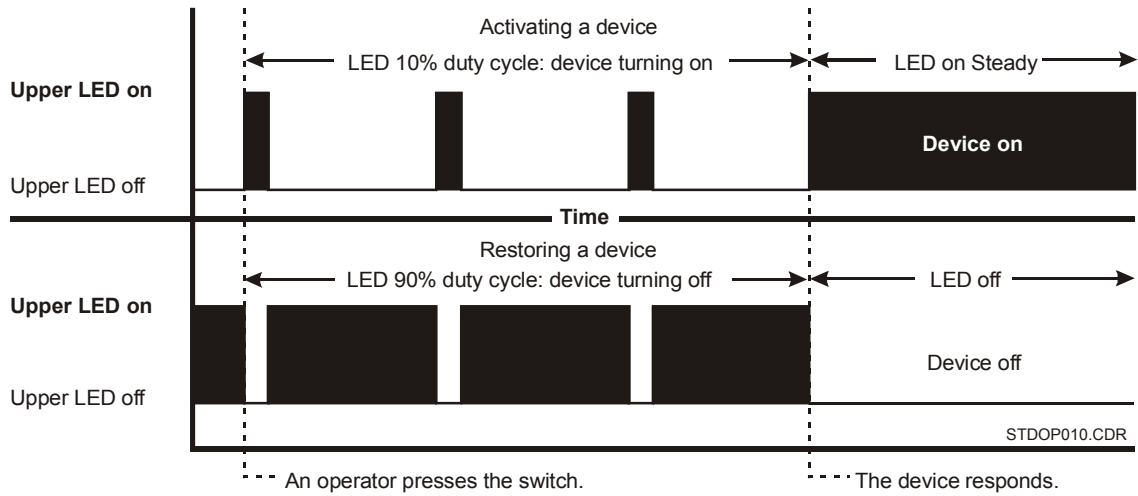

Figure 25: LED/switch module activation and restoration duty cycles

Canceling commands at the front panel

If you change your mind while a device is turning on, you can cancel the command to turn it on. Before the command is executed, press the switch a second time. The duty cycle will stop and the LED will return to its previous state. See the upper half of Figure 26.

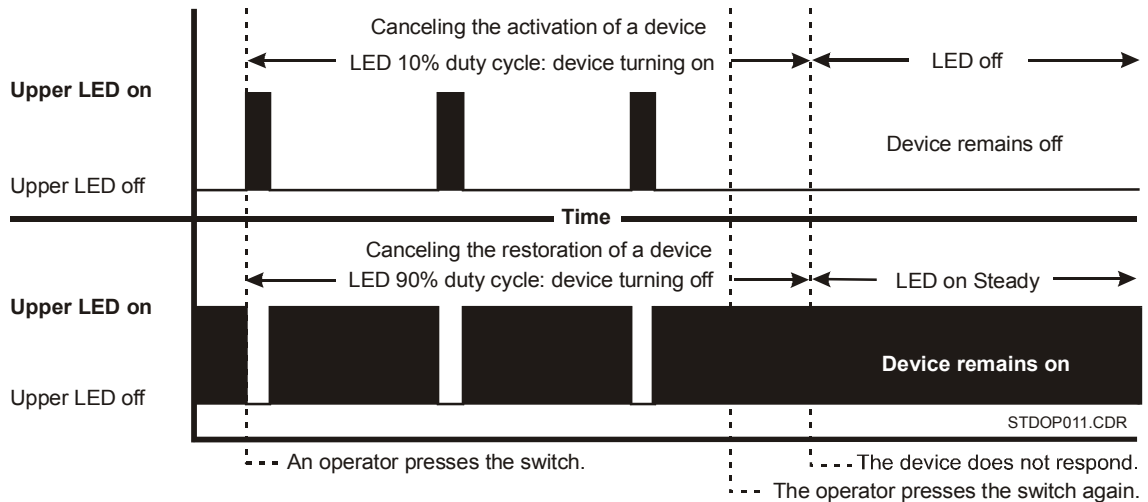

Figure 26: LED/switch module cancellation duty cycles

You may also cancel a command if you change your mind while a device is turning off. Before the command is executed, press the switch a second time. The duty cycle will stop and the LED will return to its previous state. See the lower half of Figure 26.

Operating the 2-MIC

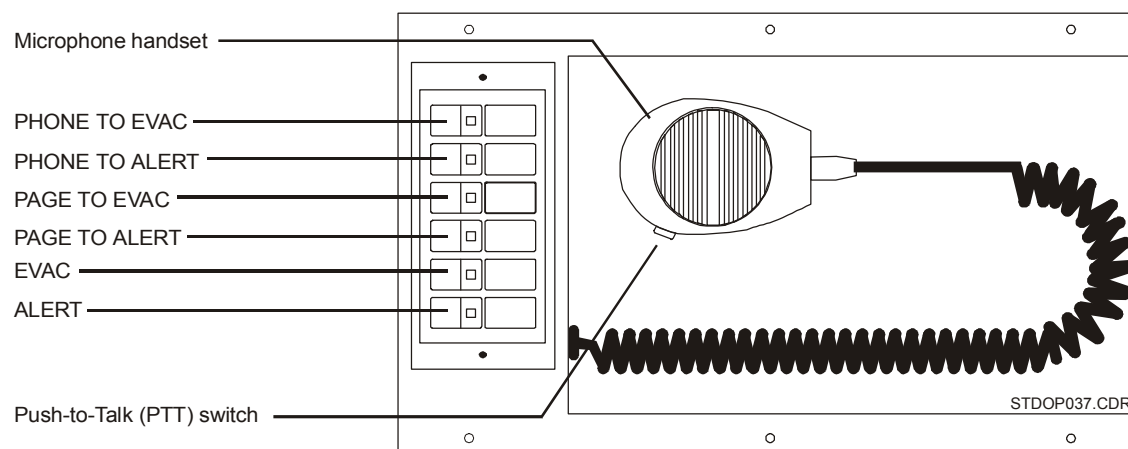

Figure 27: 2-MIC microphone module

Table 10: 2-MIC controls and indicators

Item	Control	Description
1	Phone to Evac switch	When pressed, the Phone to Evac switch immediately connects the firefighter telephone (2-TEL) to the building's evacuation area through the paging system. The Phone to Evac switch features an integral LED, which lights when it is active. See Table 11 (item 4) for the application of this switch to the 2-TEL.
2	Phone to Alert switch	When pressed, the Phone to Alert switch immediately connects the firefighter telephone (2-TEL) to the building's alert area through the paging system. The Phone to Alert switch features an integral LED, which lights when it is active. See Table 11 (item 5) for the application of this switch to the 2-TEL.
3	Page to Evac switch	When pressed, the Page to Evac switch enables the microphone and directs its output to the building's evacuation area through the paging system. The Page to Evac switch features an integral LED, which lights when it is active.
4	Page to Alert switch	When pressed, the Page to ALERT switch enables the microphone and directs its output to the building's alert area through the paging system. The Page to ALERT switch features an integral LED, which lights when it is active.
5	Evac switch	When pressed, the Evac switch manually activates the evacuation signal. The Evac switch features an integral LED, which lights when it is active. The Evac switch requires manual activation of the desired evacuation areas on the LED annunciator/switch modules. See the site-specific instructions for information on selecting specific areas within your facility.

Table 10: 2-MIC controls and indicators

Item	Control	Description
6	Alert switch	When pressed, the Alert switch manually activates the evacuation signal. The Alert switch features an integral LED, which lights when it is active. The Alert switch requires manual activation of the desired alert areas on the LED annunciator/switch modules. See the site-specific instructions for information on selecting specific areas within your facility.
7	Microphone	Use the microphone to issue a page message. See the paging procedure below.
8	Push-to-Talk [PTT] switch	When pressed, the PTT switch activates the pre-announcement tone and the microphone. The microphone will not transmit any messages until the PTT switch has been operated and the pre-announcement tone has ended.

Note: The mode setting of the 2-AAC will affect the operation of the 2-MIC. See the 2-AAC installation sheet.

To issue a page message:

1. Remove the microphone from its bracket.
2. Hold the microphone near your mouth and press the PTT switch.
3. When the pre-announcement tone ends, speak.

Operating the 2-TEL

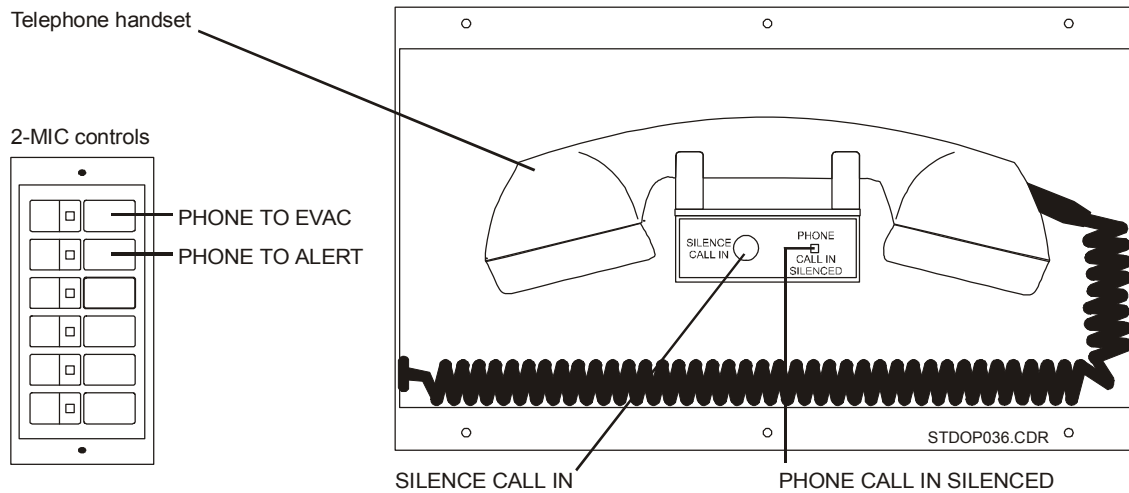

Figure 28: 2-TEL telephone module

Table 11: 2-TEL controls and indicators

Item	Control/Indicator	Description
1	Master handset	The master handset provides two-way communication for firefighter telephones located throughout the facility. Replace the handset on the hook when not in use.
2	Silence Call-In switch	When pressed, the Silence Call In switch turns off the internal call-in buzzer. Any attempt to call the master handset from a remote firefighter telephone will sound the buzzer.
3	Phone Call-In Silenced LED	When lit, the Phone Call In Silenced LED indicates that someone pressed the Silence Call-in switch to silence the internal call-in buzzer.
4	Phone to Evac switch	The Phone To Evac switch is a part of the 2-MIC. Use this switch with the 2-TEL to page the evacuation area. See the description in Table 10 (item 1).
5	Phone to Alert switch	The Phone To Alert switch is a part of the 2-MIC. Use this switch with the 2-TEL to page the alert area. See the description in Table 10 (item 2).

Operating the SIGA-MDM

The SIGA-MDM is a digital message module, which provides up to two voice quality audio messages. Each message lasts for up to 30 seconds. The SIGA-MDM can function as a standalone audio source or in conjunction with the 2-AAC.

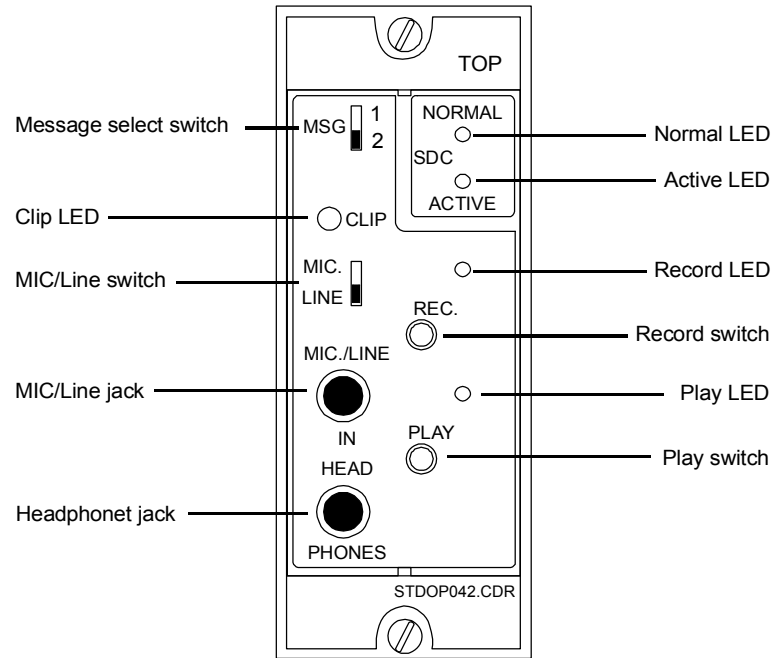

Figure 29: SIGA-MDM Digital Message Module

Table 12: Indicators

LED	Description
Clip	The Clip LED flashes while you record a message to indicate that its amplitude is exceeding the recording level. The SIGA-MDM is clipping the audio spike to hold the message's amplitude down. The Clip LED should flash only occasionally.
Normal	The Normal LED, when lit, indicates that the SIGA-MDM is communicating with the Signature Loop Controller.
Active	The Active LED, when lit, indicates that the SIGA-MDM is playing a message.
Record	The Record LED, when lit, indicates that the SIGA-MDM is recording and how much time remains.
Play	The Play LED, when lit, indicates that the SIGA-MDM is in the playback mode.

Table 13: SIGA-MDM Controls

Switch	Description
Message select	The Message Select switch, when toggled, selects the message for recording and playback.
MIC/Line select	The MIC/Line switch, when toggled, sets the audio input jack signal level.
Record	The Record switch, when pressed, turns the recording function on and off.
Play	The play switch, when pressed, turns the play function on and off.

Table 14: SIGA-MDM Jacks

Jacks	Description
MIC/Line in	The MIC/Line jack accepts the microphone or remote source for recording.
Head phones	The Head Phones jack accepts the headphones for playback.

Chapter 3

Operating remote devices

Summary

The EST2 system works with several remote annunciators and SAN series annunciators. This chapter provides instructions for interpreting annunciator messages and indications. It also provides instructions for operating annunciator control switches.

Content

- Operating remote alphanumeric annunciators • 54
 - 2-SMDN(-C) • 54
 - 2-CMDN(-C) • 55
 - 2-LSRA(-C) • 56
 - Controls and indicators • 56
 - Reading LCD messages • 60
- Reading and operating SAN annunciators • 61
 - 2-SANCOM • 62
 - SLU-16 • 64
 - SWU-8 • 65
 - SWU-8/3 • 66
 - SHO-4 • 67
 - Selecting system functions on SAN annunciators • 68
 - SAN-MIC II • 70

Operating remote alphanumeric annunciators

2-SMDN(-C)

Figure 30 shows the 2-SMDN and the 2-SMDN-C. The 2-SMDN offers only the ability to acknowledge and review messages. The 2-SMDN-C also features indicators and operator input switches.

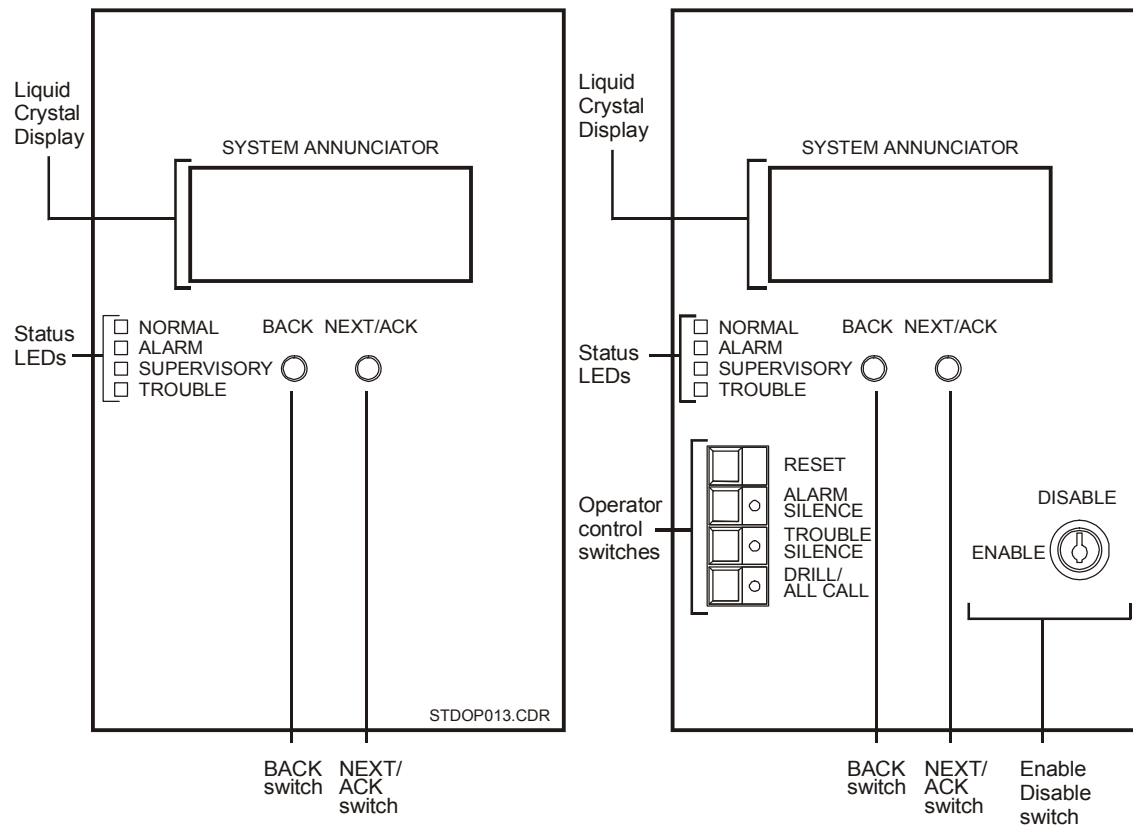

Figure 30: 2-SMDN (left), 2-SMDN-C (right)

2-CMDN(-C)

Figure 31 shows the 2-CMDN-C and the 2-CMDN. The 2-CMDN offers only the ability to acknowledge and review messages. The 2-CMDN-C also features indicators and operator input switches.

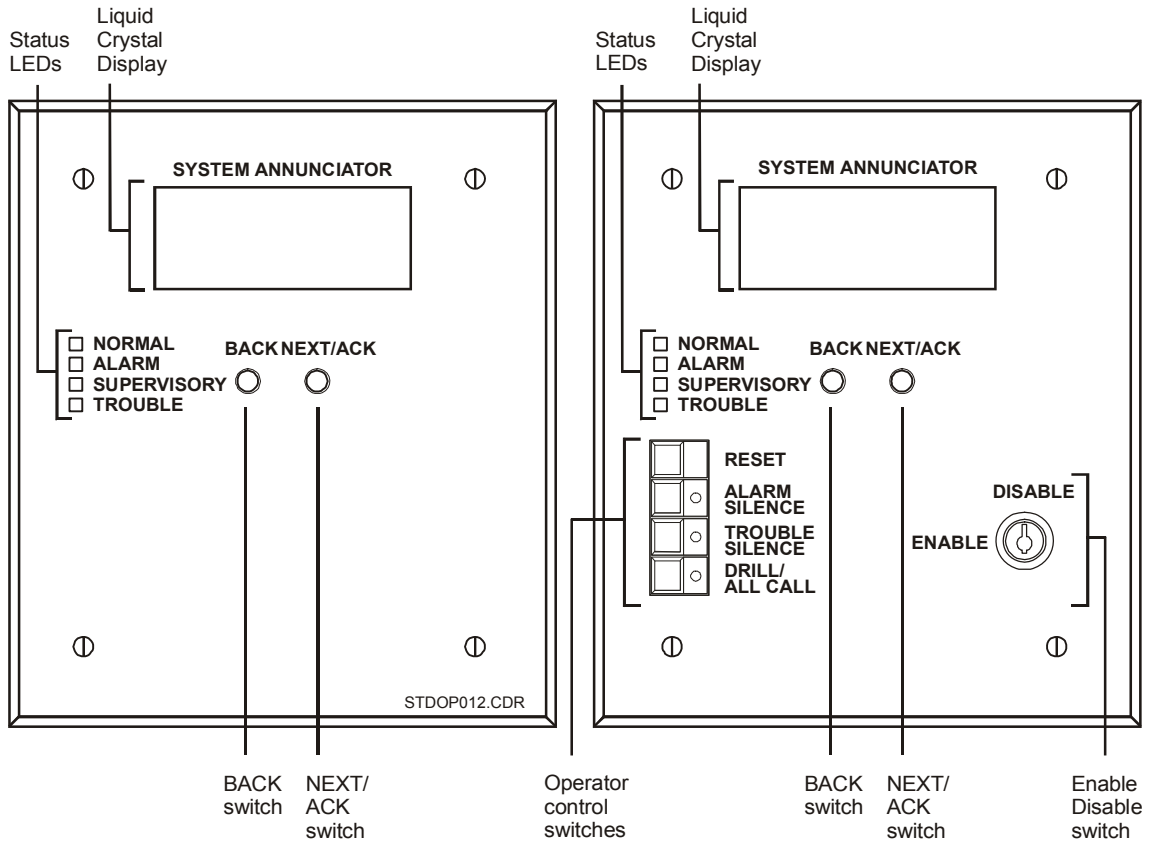

Figure 31: 2-CMDN (left), 2-CMDN-C (right)

2-LSRA(-C)

Figure 32 shows the 2-LSRA and the 2-LSRA(-C). The 2-LSRA offers only the ability to acknowledge and review messages. The 2-LSRA(-C) also features indicators and operator input switches.

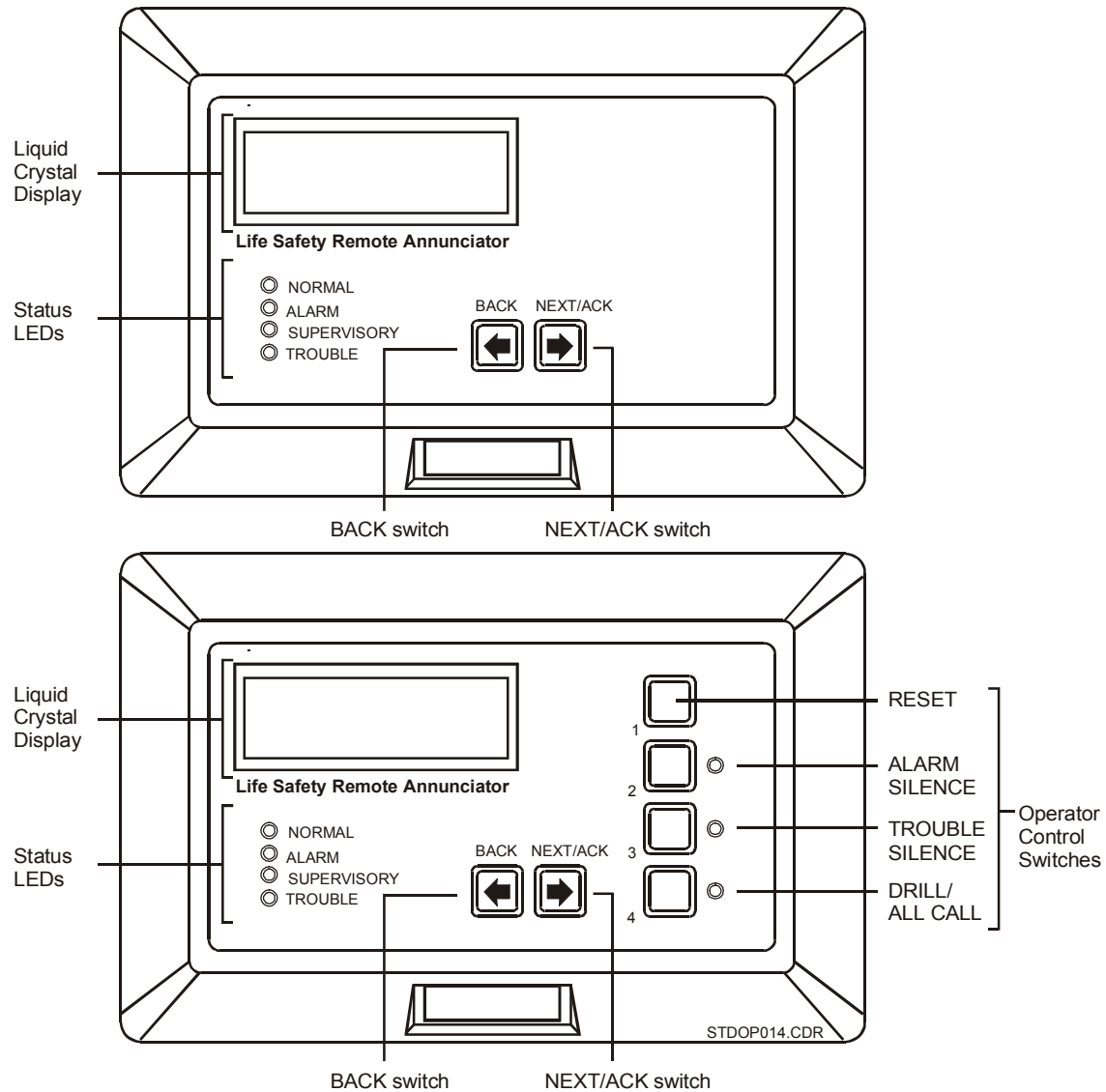

Figure 32: 2-LSRA (top), 2-LSRA-C (bottom)

Controls and indicators

Table 15: Remote alphanumeric annunciator controls

Control	Availability	Description
Next/Ack switch	2-SMDN-C 2-SMDN 2-CMDN-C 2-CMDN 2-LSRA(-C) 2-LSRA	The Next/Ack switch, when pressed, acknowledges the receipt of new messages at the remote alphanumeric annunciator and automatically advances to the next unacknowledged message. When there are no unacknowledged messages, the Next/Ack switch may be used to scroll forward through the review buffer. The review buffer only displays active points. A point will not appear in the review buffer if it becomes active and restores.
Back switch	2-SMDN-C 2-SMDN 2-CMDN-C 2-CMDN 2-LSRA(-C) 2-LSRA	The Back switch, when pressed, scrolls in reverse through the review buffer. Press the Back and Next/Ack switches simultaneously to clear the LCD after the acknowledgement of every message.
Enable/Disable switch	2-SMDN-C 2-CMDN-C	The Enable/Disable switch requires a key. Depending on which position you turn the key to, and the way the switch is configured, it can enable or disable any combination of the front panel Reset, Alarm Silence, Trouble Silence, and Drill switches.
Reset switch	2-SMDN-C 2-CMDN-C 2-LSRA(-C)	The Reset switch, when pressed, directs the control panel to issue a system-wide reset command after all system wide-status points have been acknowledged.
Alarm Silence switch	2-SMDN-C 2-CMDN-C 2-LSRA(-C)	The Alarm Silence switch, when pressed, directs the control panel to issue a system-wide alarm silence command. Operating the Alarm Silence switch generates a trouble LED on the display and activates the internal trouble buzzer. Pressing the Alarm Silence and Local Silence switches simultaneously starts a 15 second LED test sequence.
Trouble Silence switch	2-SMDN-C 2-CMDN-C 2-LSRA(-C)	The Trouble Silence switch, when pressed, silences the local trouble buzzer after all messages have been acknowledged. This is a system-wide function.
Drill/ All Call switch	2-SMDN-C 2-CMDN-C 2-LSRA(-C)	The Drill/ All Call switch, when pressed, directs the control panel to issue a drill command.

Note: You do *not* have to acknowledge messages at the remote alphanumeric annunciators. You can acknowledge the message at the control panel. The system automatically acknowledges and silences any message through the Local Silence switch. Upon the acknowledgment of the message, the control panel will restore the remote alphanumeric annunciators.

Table 16: Remote alphanumeric annunciator indicators

Event	Indication	Regional patterns		Availability	Notes
		US/Can	Europe		
Normal operations	Green LED	Steady	Steady	2-SMDN-C 2-SMDN 2-CMDN-C 2-CMDN 2-LSRA(-C) 2-LSRA	Indicates that the system has no faults or off-normal conditions.
Alarm condition	Red LED	Steady	Steady	2-SMDN-C 2-SMDN 2-CMDN-C 2-CMDN 2-LSRA(-C) 2-LSRA	Indicates that the system has detected a fire alarm condition.
Trouble condition	Amber LED	Steady	Steady	2-SMDN-C 2-SMDN 2-CMDN-C 2-CMDN 2-LSRA(-C) 2-LSRA	Indicates that some portion of the system is off-normal, and may degrade the system's operation.
Supervisory condition	Amber LED	Steady	Steady	2-SMDN-C 2-SMDN 2-CMDN-C 2-CMDN 2-LSRA(-C) 2-LSRA	Indicates that a fire protection system other than the fire alarm panel is off-normal. Closed sprinkler valves and disabled supplementary fire extinguishing systems may cause supervisory conditions.
Unacknowledged message	Internal buzzer	Pulses	Pulses	2-SMDN-C 2-SMDN 2-CMDN-C 2-CMDN 2-LSRA(-C) 2-LSRA	The operator must acknowledge all messages to silence the buzzer.
Trouble	Internal buzzer	Pulses	Steady	2-SMDN-C 2-SMDN 2-CMDN-C 2-CMDN 2-LSRA(-C) 2-LSRA	In Europe, the buzzer will pulse steadily until an operator silences it. When the buzzer is silenced, it will generate a half-second pulse every 14 seconds as a reminder of the trouble condition.

Table 16: Remote alphanumeric annunciator indicators

Event	Indication	Regional patterns		Availability	Notes
		US/Can	Europe		
Alarm silence	Amber LED	Flash	Flash	2-SMDN-C 2-CMDN-C 2-LSRA(-C)	The Alarm Silence LED lights when the system-wide alarm silence function has been initiated.
Trouble or supervisory condition silence	Amber LED	Flash	Flash	2-SMDN-C 2-CMDN-C 2-LSRA(-C)	The Trouble Silence LED lights when the system-wide trouble silence function has been initiated. 2-SMDN, 2-CMDN, and 2-LSRA buzzers sound <i>only</i> for unacknowledged messages.
Drill/all call test	Amber LED	Flash	Flash	2-SMDN-C 2-CMDN-C 2-LSRA(-C)	The Drill LED lights when the system-wide drill/all call function has been initiated.

Reading LCD messages

The 2-CMDN(-C), the 2-SMDN(-C), and the 2-LSRA(-C)) feature a liquid crystal display (LCD). The LCD turns off after 4 minutes of inactivity to save power. Any change of state, off-normal condition, or front panel switch activation will turn on the LCD's back-lighting. The system's main controller module automatically updates time and date information. The LCD does not display point address information unless the system programmer includes it as part of the message.

Figure 33 illustrates an LCD with no messages pending. The fire alarm system has no problems at the moment of the display. In Figure 34, however, the LCD indicates a trouble condition for a Signature series device in the Janitor's closet.

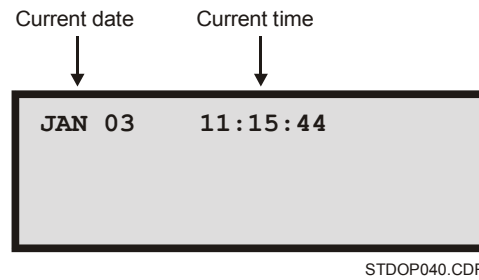

Figure 33: LCD during normal conditions

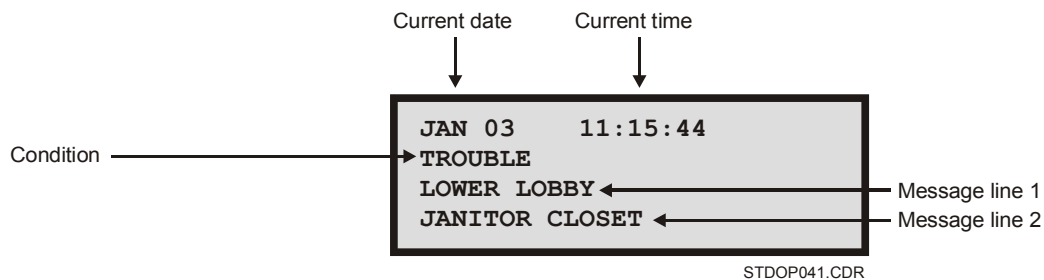

Figure 34: Sample alarm message on the LCD

Reading and operating SAN annunciators

SAN annunciators provide point status indication and switching functions at a location remote from the fire alarm control panel. Each SAN annunciator requires a SAN-CPU. This section discusses the indicators and controls of the following SAN annunciators:

- 2-SANCOM
- SLU-16
- SWU-8(/3)
- SHO-4

2-SANCOM

The 2-SANCOM Remote Network Control module provides basic network indicators and controls in a SAN series package.

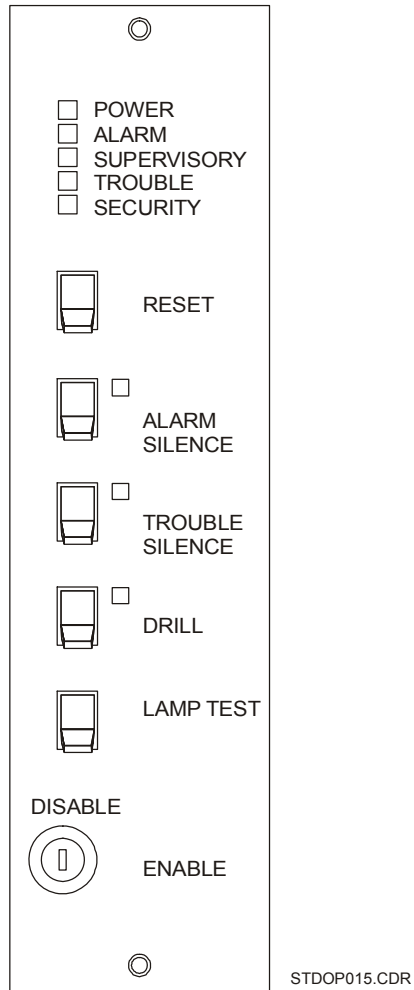

Figure 35: 2-SANCOM

Table 17: 2-SANCOM indicators

Indicator	Description
Power LED	The Power LED, when lit, indicates that the system has no faults or off-normal conditions.
Alarm LED	The Alarm LED, when lit, indicates that the system has detected a fire alarm condition.
Supervisory LED	The Supervisory LED, when lit, indicates that a fire protection system other than the fire alarm panel is off-normal.
Trouble LED	The trouble LED, when lit, indicates that some portion of the system is off-normal, and may degrade the system's operation.
Alarm Silence LED	The Alarm Silence LED lights when the system-wide alarm silence function has been initiated.
Trouble Silence LED	The Trouble Silence LED lights when the system-wide trouble silence function has been initiated.
Drill LED	The Drill LED lights when the system-wide drill/ all call function has been initiated.
Security LED	The Security LED, when lit, indicates a security condition.
Trouble buzzer	Operates on system trouble, and when the trouble silence is in the off-normal position when no trouble exists on the system

Table 18: 2-SANCOM controls

Control	Description
Reset switch	The Reset switch, when toggled, directs the control panel to issue a system-wide reset command after all the system wide-status points have been acknowledged.
Alarm Silence switch	The Alarm Silence switch, when toggled, directs the control panel to issue a system-wide alarm silence command. Operating the Alarm Silence switch lights the Trouble LED on the 2-LCD and activates the internal trouble buzzer. Toggling the Alarm Silence and Local Silence switches simultaneously starts a 15-second LED test sequence.
Trouble Silence switch	The Trouble Silence switch, when toggled, silences the local trouble buzzer after all messages have been acknowledged. This is a system-wide function.
Drill/All Call switch	The Drill/All Call switch, when toggled, directs the control panel to issue a drill command.
Enable/Disable switch	The Enable/Disable switch requires a key. Depending on which position you turn the key to, and the way the switch is configured, it can enable or disable any combination of the front panel Reset, Alarm Silence, Trouble Silence, and Drill switches.
Lamp Test switch	The Lamp Test, when toggled, tests all the 2-SANCOM indicators.

SLU-16

The SLU-16 Remote Annunciator Lamp module has 16 LEDs for remote annunciator applications when using the SAN-CPU. The system software individually controls all LEDs and switches. When a pre-defined input exists on the system, the appropriate LED will illuminate to report the condition.

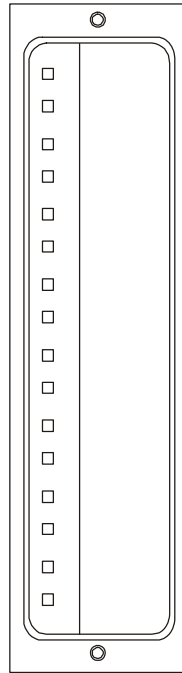

STDOP017.CDR

Model
SLU-16R
SLU-16Y
SLU-16R/Y

Description
16 red LEDs
16 yellow LEDs
8 red LEDs/8 yellow LEDs

Figure 36: SLU-16

SWU-8

The SWU-8 consists of 8 two-position toggle switches and 16 red or yellow LEDs. Each switch forms a distinct functional group with two independently programmed LEDs. Placing a switch in the up position generates an active (off normal) condition. The down position is the normal state.

In a typical firefighter telephone application using the SWU-8, the upper switch position selects an incoming call; the lower switch position places the circuit to normal or off-line operation. One of the associated LEDs indicates the circuit calling in; the other LED indicates that the circuit has been connected to the master handset.

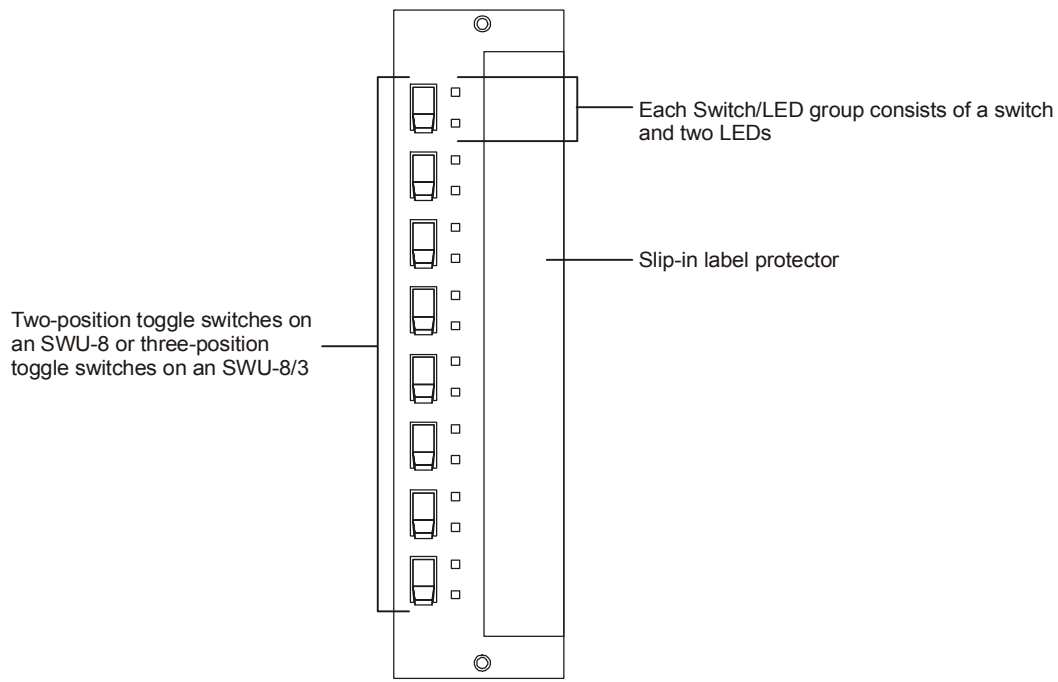

STDOP016.CDR

Figure 37: SWU-8(/3)

SWU-8/3

The SWU-8/3 consists of 8 three-position toggle switches and 16 red or yellow LEDs. Each switch forms a distinct functional group with two independently programmed LEDs. Placing a switch in the up or down positions generates one of two active (off-normal) conditions. The center position is the normal state.

In a typical HVAC application, the SWU-8/3 switches may be used as hands off automatic (HOA) controls to override the automatic operation of the system. The two associated LEDs may be programmed to indicate the status of Run/Stop contacts, fans or dampers with limit switches, etc.

In typical audio evacuation application using the SWU-8/3, the upper switch position initiates circuit paging. The center switch position allows normal/automatic control mode of the speaker circuit. The LEDs indicate the active condition of the speaker circuit.

SHO-4

The SHO-4 module provides 4 three-position rotary switches and 12 LEDs for remote switching and annunciator applications. Two yellow LEDs and one green LED are positioned next to each switch. The yellow LEDs operate independent of the switches, which the system program controls. The green LED illuminates when the switch is in the center position. Typical applications include Hand-Off-Automatic (HOA) control and the override of automatic systems.

The SHO-4 switches activate control fans, dampers, etc. The center switch position is the automatic operational position. The switch, in the center position, lights the green LED to show that the HVAC system is using its normal control cycle.

In a typical program, the upper switch position forces the device to turn on through a control module or zone. The lower switch position forces the device to turn off again. Status zones connected to vane or limit switches, contractor status switches, etc. activate the upper and lower LEDs to indicate a device's status.

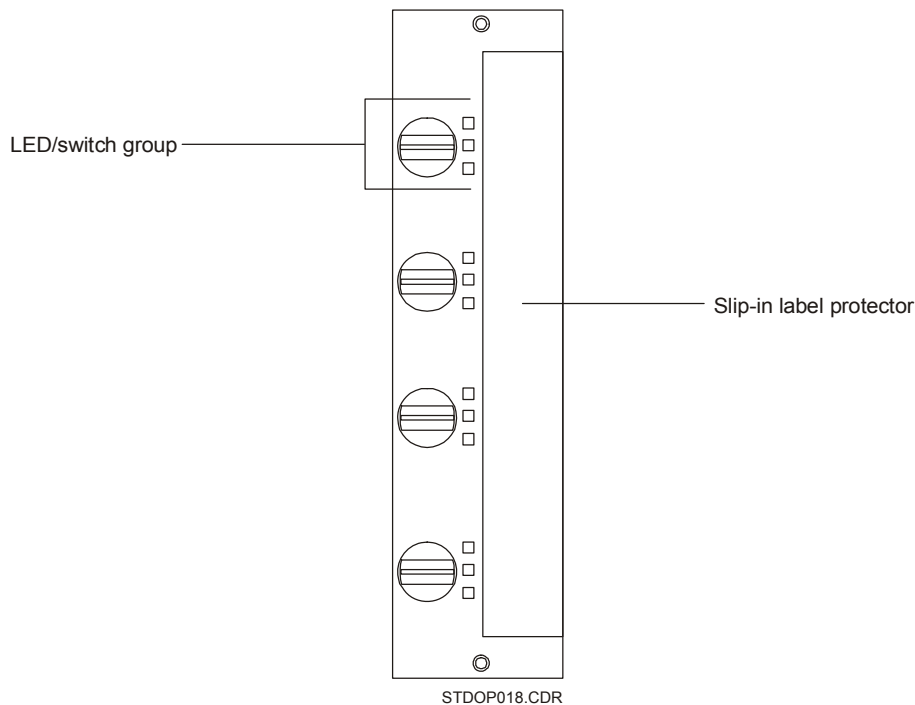

Figure 38: SHO-4 Remote annunciator lamp and switch module

Selecting system functions on SAN annunciators

The SWU-8 series annunciators provide two-position and three-position toggle switch options. The SHO-4 provides three-position rotary switches. Apart from operator intervention the SAN annunciators will allow the system to function automatically. During off-normal conditions, however, the operator has the option of toggling or turning switches to activate programmed functions or override normal system functions.

Each three-position toggle switch has two LEDs. When the switch is in the center position, the system will function automatically and keep both LEDs off. When an operator toggles the switch up or down, it will activate a programmed function, and turn on the appropriate LED.

The three-position rotary switch is like the three-position toggle switch, but it has a third LED. When the switch is in the center position the system will function automatically and turn on the center LED. The upper and lower LEDs operate independent of the switch.

The two-position toggle switch has two LEDs. When the switch is down the system will function automatically. When an operator toggles the switch up, it will activate a programmed function and turn on the upper LED.

Three-position toggle switch: SWU-8/3

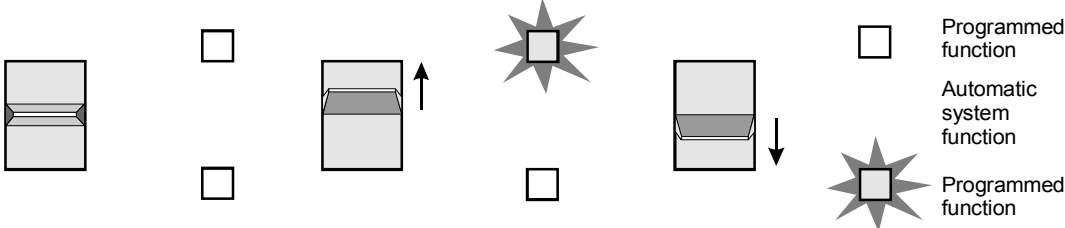

Three-position rotary switch: SHO-4

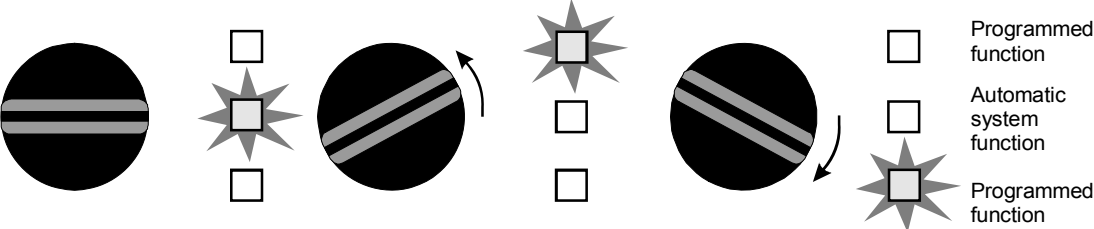

Two-position toggle switch: SWU-8

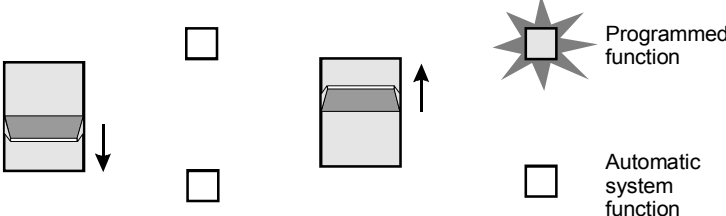

LED indications	
LED is off:	<input type="checkbox"/>
LED is on:	<input checked="" type="checkbox"/>
STDOP020.CDR	

Figure 39: SAN annunciator switch positions

SAN-MIC II

The SAN-MIC II module is a supervised microphone capable of operation remotely from the audio power amplifier. The SAN-MIC II provides a pre-amp level signal, which may be transmitted over 2,000 feet of shielded cable. In addition, the SAN-MIC II provides a PTT dynamic microphone, a solid state VU meter, and a supervisory pulse generator.

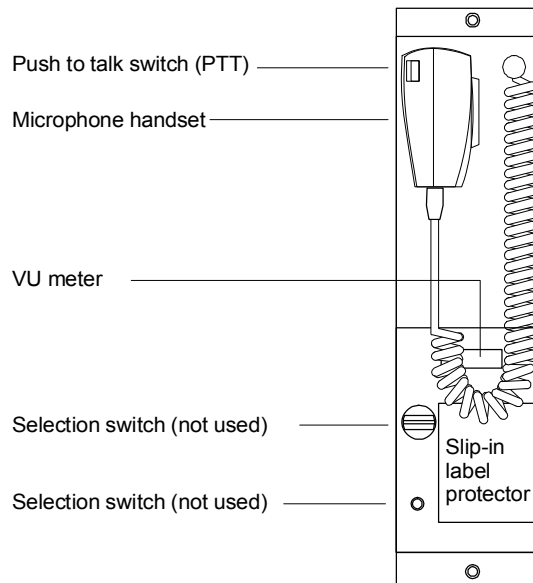

Figure 40: SAN-MIC II and emergency tone select positions

In the normal state, the SAN-MIC II generates a supervisory pulse tone for supervision of the audio wiring and circuitry.

Switches

The *Microphone PTT* sends the microphone output to the module output terminals. The activation of the microphone PTT closes the speaker select relay.

VU meter

The VU meter is a row of LEDs that form a bar graph to indicate the input level from the microphone. The amplitude of your voice determines the microphone's input level. If the bar graph does not light up when you talk, you may not be talking loud enough. If the bar graph runs all the way to the left, you are talking too loud. The ideal indication on the VU meter is a bar graph that runs to the middle.

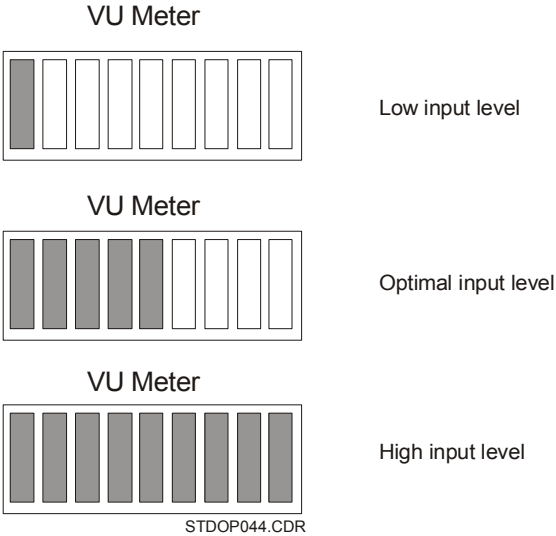

Figure 41: SAN-MIC II VU meter

Chapter 4

Operating peripheral devices

Summary

The EST2 system interfaces with the PT-1S printer and the RSAN-PRT printer. This chapter discusses the controls and indicators of the PT-1S and the RSAN-PRT.

Content

PT-1S Printer • 74
RSAN-PRT Printer • 76

PT-1S Printer

The PT-1S printer provides permanent records of all system activities, including sensitivity and history reports. The PT-1S remains continuously active unless someone uses the printer connection for maintenance purposes. The printer operates in combination with the 2-LCD. See *Generating reports in Operating panel devices*. The printer will generate a trouble condition at the control panel if it has an internal problem or runs out of paper.

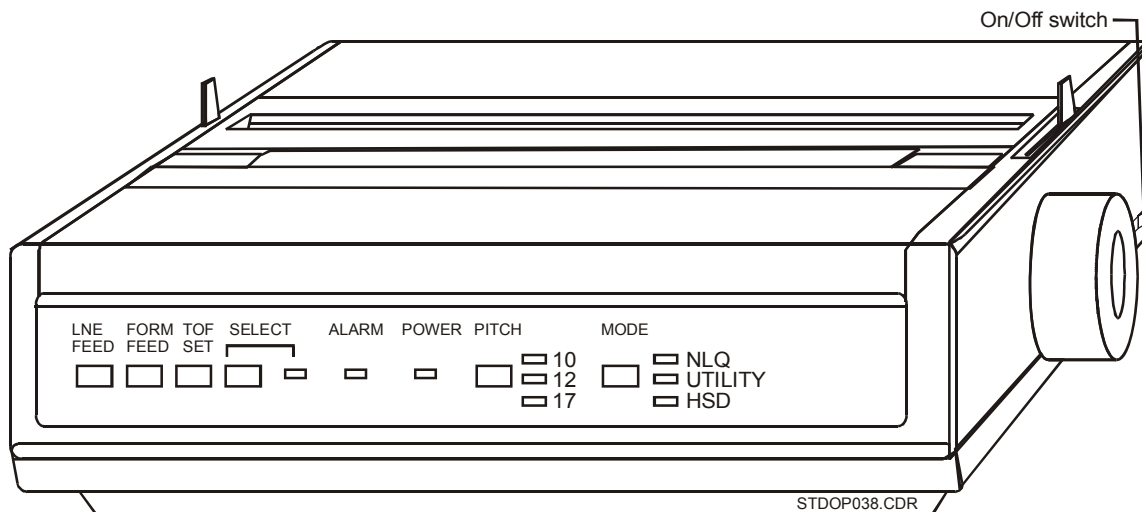

Figure 42: PT-1S form printer

Table 19: Indicators

LED	Color	Description
Select	Green	The Select LED turns on when the printer is online.
Alarm	Red	The Alarm LED lights turns on when the printer has an internal problem or needs more paper. Do not confuse this LED with a fire alarm.
Power	Green	The Power LED turns on when the printer has power.
Pitch	Green	The Pitch LEDs turn on to indicate the selected character size.
Mode	Green	The Mode LEDs turn on to indicate the selected printer speed.

Table 20: Controls

Switch	Description
Line feed	Advances the paper one line.
Form feed	Advances the paper to the next page.

Table 20: Controls

Switch	Description
TOF set (Top of Form)	Sets the top margin at the current location of the printhead. Make sure the printer is offline if you manually set the paper at the page break.
Select	Turns the printer online or offline. The Select switch also features an LED to indicate whether the printer is online or offline.
Pitch	Sets the print character size.
10	10 characters per inch (recommended setting)
12	12 characters per inch
17	17 characters per inch
Mode	Sets the print speed.
NLQ	Near letter quality: slowest (not recommended)
Utility	Draft quality: medium (recommended setting)
HSD	High speed draft: fastest
On/Off	Applies power to the printer in the On position. Removes power from the printer in the Off position.

RSAN-PRT Printer

The RSAN-PRT printer provides permanent records of all system activities, including sensitivity and history reports. The RSAN-PRT remains continuously active unless someone uses the printer connection for maintenance purposes. The printer operates in combination with the 2-LCD. See *Generating reports* in *Operating panel devices*. The printer will generate a trouble condition at the control panel if it has an internal problem or runs out of paper.

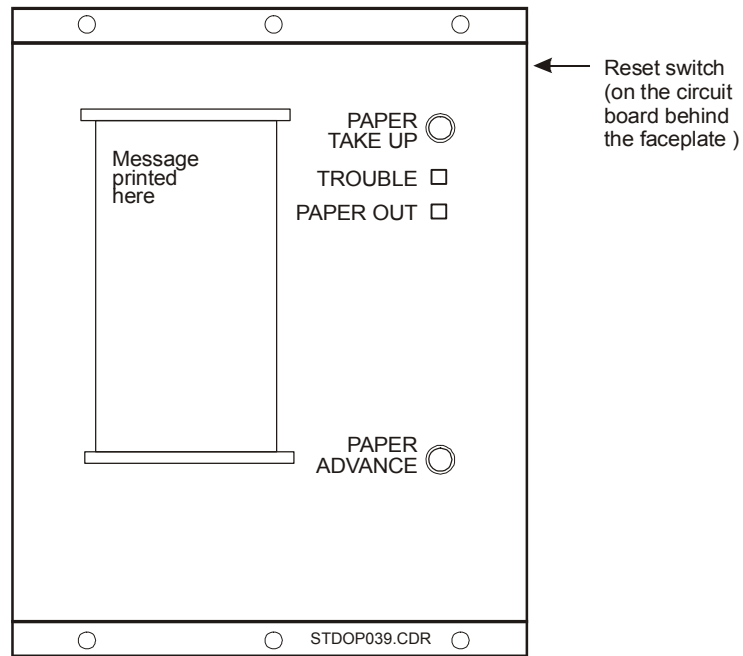

Figure 43: RSAN-PRT strip printer

Table 21: Indicators

LED	Color	Description
Trouble	Yellow	The Paper out LED turns on when the printer requires paper.
Paper out	Yellow	The Trouble LED turns on when the printer has an internal trouble or a printer down line is not responding to supervision requests.

Table 22: Controls

Control	Description
Reset	Restarts and reinitializes the printer.
Paper take up	Winds the paper on the take-up spool.
Paper advance	Winds the paper one line at a time.

Appendix A

Operator instructions

Summary

Before you complete the installation of the fire alarm system, follow the instructions in this appendix. When you complete the information on the operator instructions, post them at or near the fire alarm control panel.

Content

Posting operator instructions • 78

Posting operator instructions

The following pages feature two sets of operator instructions. The first set of instructions (Figure 44) outlines the procedures for operating the fire alarm panel without emergency communications equipment.

The second set of instructions (Figure 45) provides the procedures for operating the fire alarm control panel with emergency communications equipment.

To post operator instructions:

1. Photocopy the master set of operator instructions.
2. Write down the location of control panel in the space provided at the top of the form.
3. Complete the information in the installation column of each instruction set.
4. Frame the operator instructions.
5. Mount the operator instructions next to the control panel.

Fire Alarm Control Panel Operating Instructions	
<p>Installed By: _____ _____ _____</p> <p>Per NFPA Standard:</p> <p><input type="checkbox"/> 72, Ch 6 - Prot. Prem. <input type="checkbox"/> 72, Ch 9 - Auxiliary <input type="checkbox"/> 72, Ch 8 - Remote Sta. <input type="checkbox"/> 72, Ch 8 - Proprietary <input type="checkbox"/> 72, Ch 8 - Central Sta.</p> <p>Dated: _____</p>	<p>Location: _____</p> <p>Normal Condition: The Power LED (green) is on. All other LEDs are off.</p> <p>Alarm Condition: The Alarm LED (red) turns on, the display shows the alarm location and zone, and the internal buzzer pulses.</p> <p>To view other alarm messages: Press the ALARM review switch (down arrow). To silence audible devices: Press the Alarm Silence switch. To reset the system: Find the cause of the alarm condition, correct it, and press the Reset switch.</p> <p>Note: Each new alarm will resound the audible devices, but you cannot resound them by pressing the Alarm Silence switch a second time.</p> <p>Supervisory Condition: The Supervisory LED (yellow) turns on, the display shows the supervisory condition, location, and zone, and the internal buzzer pulses.</p> <p>To view other supervisory messages: Press the SUPVR review switch (down arrow). To silence buzzer: Press Local Silence switch. To clear the system: Find the cause of supervisory condition, correct it, and press the Reset switch.</p> <p>Trouble Condition: The system Trouble LED (yellow) turns on, the display shows the trouble location and zone, and the internal buzzer pulses.</p> <p>To view other trouble messages: Press the TRBLE review switch (down arrow). To silence the buzzer: Press the Local Silence switch. To clear the system: Find the cause of the trouble and correct it. The system automatically clears itself upon correction of trouble condition.</p> <p>Monitor Condition: The Monitor LED (yellow) turns on, the display shows monitor conditions, and the internal buzzer pulses during a non-fire alarm condition.</p> <p>To view other monitor conditions: Press the MONTR review switch (down arrow). To clear system: The system automatically clears itself upon restoration of monitor condition.</p> <p>Fire Drill: Notify the fire department before you run the test. All audible and visual notification appliances will operate during a drill.</p> <p>To drill all notification appliances: Press the Drill switch. To end the drill: Press the Drill switch a second time, or press Alarm Silence.</p> <p>Frame these instructions and mount them next to the fire alarm control panel. For additional information, See the <i>System Operations Manual</i>.</p>
<p>For Service Contact:</p> <p>_____ _____ _____ _____</p>	
<p>Inspected By:</p> <p>_____ _____ _____</p> <p>Date: _____</p>	
<p>Power Supply:</p> <p>Primary _____ Location _____ Fuses _____ Secondary _____ Type _____ Specs. _____</p>	

Figure 44: Fire alarm control panel operating instructions

Emergency Communications Operating Instructions	
<p>Installed By: _____ _____ _____</p> <p>Per NFPA Standard: <input type="checkbox"/> 72, Ch 6 - Prot. Prem. <input type="checkbox"/> 72, Ch 9 - Auxiliary <input type="checkbox"/> 72, Ch 8 - Remote Sta. <input type="checkbox"/> 72, Ch 8 - Proprietary <input type="checkbox"/> 72, Ch 8 - Central Sta.</p> <p>Dated: _____</p>	<p>Location: _____</p> <p>Normal Condition: The Power LED (green) is on. All other LEDs are off.</p> <p>Alarm Condition: The Alarm LED (red) turns on, the display shows the alarm location and zone, and the internal buzzer pulses.</p> <p style="padding-left: 20px;">To view other alarm messages: Press the ALARM review switch (down arrow). To silence audible devices: Press the Alarm Silence switch. To reset the system: Find the cause of alarm condition correct it, and press the Reset switch.</p> <p>Note: Each new alarm will resound the audible devices, but you cannot resound them by pressing the Alarm Silence switch a second time.</p> <p>Supervisory Condition: The Supervisory LED (yellow) turns on, the display shows the supervisory condition, location, and zone, and the internal buzzer pulses.</p> <p style="padding-left: 20px;">To view other supervisory messages: Press the SUPVR review switch (down arrow). To silence buzzer: Press Local Silence switch. Investigate the cause. To clear the system: Find the cause of the supervisory condition, correct it, and press the Reset switch.</p> <p>Trouble Condition: The system Trouble LED (yellow) turns on, the display shows the trouble location and zone, and the internal buzzer pulses.</p> <p style="padding-left: 20px;">To view other trouble messages: Press the TRBLE review switch (down arrow). To silence the buzzer: Press the Local Silence switch. To clear the system: Find the cause of the trouble and correct it. The system automatically clears itself upon correction of trouble condition.</p> <p>Monitor Condition: The Monitor LED (yellow) turns on, the display shows monitor conditions, and the internal buzzer pulses during a non-fire alarm condition.</p> <p style="padding-left: 20px;">To view other monitor conditions: Press the MONTR review switch (down arrow). To clear system: The system automatically clears itself upon restoration of monitor condition.</p>
<p>For Service Contact: _____ _____ _____</p>	<p>Fire Drill: Notify the fire department before you run the test. All audible and visual notification appliances will operate during a drill.</p> <p style="padding-left: 20px;">To drill all notification appliances: Press the Drill switch. To end the drill: Press the Drill switch a second time, or press Alarm Silence.</p> <p>Microphone Operation:</p> <p style="padding-left: 20px;">To page the fire area:</p> <ol style="list-style-type: none"> 1 Pick up the microphone handset. 2 Press the Page-to-Evac switch. 3 Press the Push-to-Talk (PTT) switch on the microphone. 4 When the pre-announcement tone ends, speak into the microphone. <p style="padding-left: 20px;">To page the alert area:</p> <ol style="list-style-type: none"> 1 Pick up the microphone handset. 2 Press Page-to-Alert switch. 3 Press the PTT switch on the microphone. 4 When the pre-announcement tone ends, speak. <p>Telephone Operation: The buzzer indicates an incoming call.</p> <p style="padding-left: 20px;">To respond to an incoming call:</p> <ol style="list-style-type: none"> 1 Pick up the telephone handset. 2 Press the Silence Call-In switch. 3 Select the incoming phone circuit on the LED/Switch module. 4 Communicate with the calling party. <p style="padding-left: 20px;">To page by phone:</p> <ol style="list-style-type: none"> 1 Pick up the telephone handset. 2 Press the Phone-to-Evac (or Alert) switch. 3 When the pre-announcement tone ends, speak.
<p>Inspected By: _____ _____ _____</p> <p>Date: _____</p>	<p>Power Supply:</p> <p>Primary _____</p> <p>Location _____</p> <p>Fuses _____</p> <p>Secondary _____</p> <p>Type _____</p> <p>Specs. _____</p>
<p>Frame these instructions and mount them next to the emergency communications panel. For additional information, see the <i>System Operations Manual</i>.</p>	

Figure 45: Emergency communications operating instructions

Index

2

- 2-CMDN(-C) • 55, 56–60
- 2-LCD
 - control switches • 10–11
 - function switches • 13, 22–45
 - keypad • 12
 - LEDs • 10
 - message review switches • 11
- 2-LSRA(-C) • 56–60
- 2-MIC • 48–49
- 2-SANCOM • 62–63
- 2-SMDN(-C) • 54, 56–60
- 2-TEL • 50

A

- accessing the system status menu • 22
- ACp1 indication • 23
- actions
 - activation of • 37
 - disabling of • 35
 - enabling of • 32
 - restoration of • 39
- Activate switch • 13
- activating system devices/functions • *See under*
 - actions; outputs; sequences; smoke sensitivity levels. *See also* LED/switch modules
- Active LED, SIGA-MDM • 51
- addresses, panel • 29
- alarm silence
 - 2-CMDN(-C) • 56
 - 2-LSRA(-C) • 56
 - 2-SMDN(-C) • 56
- Alarm Silence switch • 11
- Alarm switch • 11
- Alert switch, 2-MIC • 48
- alerting building occupants • *See* Alert switch, 2-MIC;
 - Phone to Alert switch, 2-MIC
- Ann1 indication • 23
- annunciators, SAN • 61–71
- autoprogramming • *See* reconfiguring SLCs

B

- Bal1 indication • 23
- Bat1 indication • 23

buzzers

- 2-CMDN(-C) • *See* trouble silence
- 2-LCD • *See* local silence
- 2-LSRA(-C) • *See* trouble silence
- 2-SMDN(-C) • *See* trouble silence
- 2-TEL • *See* Silence Call-In switch

C

- canceling commands • 47
- changing system passwords • 28–29
- checking system status • *See under* status screens, 2-LCD
- Clip LED, SIGA-MDM • 51
- Com1 indication • 23
- communicating with firefighters • *See* master handset, 2-TEL
- communication classes • 29
- computers, laptop
 - disabling of • 36
 - enabling of • 33
- conditions, trouble • 18
- control switches, 2-LCD • 10–11
- controls • *See under* switches
- CPU
 - failure indication • 10
 - restarting of • 30

D

- date, system • 28
- Delete switch • 12
- devices, disabled • 25–27
- Dia1 indication • 23
- digital message module • *See* SIGA-MDM
- Disable switch • 13
- disabling system functions • *See under* actions; laptop
 - computers; mapping; messages; panel addresses; RS-485 channels; sequences; time controls; zones
- displays, 2-LCD
 - disabled devices/functions • 25–27
 - field panel status • 24
 - fire alarm message • 14
 - general status • 22
 - history report • 42
 - loop status • 23
 - reading of • 14

displays, 2-LCD (continued)
 relay/LED status • 25
 sensitivity report • 40, 41
 system status • 22
 test screens • 44, 45

Drill switch • 11
drill test • 21
duty cycles, LED/switch module • 47

E

Enable switch • 13
enabling system functions • *See under* actions; laptop computers; mapping; messages; panel addresses; RS-485 channels; sequences; time controls; zones
ending the test function • 45
Enter switch • 12
Evac switch, 2-MIC • 48
evacuating building occupants • *See* Evac switch, 2-MIC; Phone to Evac switch, 2-MIC

F

fire alarms • 17
firefighter telephone • *See* 2-TEL
function switches, 2-LCD
 Activate • 37–38
 described • 13
 Disable • 34–36
 Enable • 31–33
 Program • 28–30
 Reports • 40–43
 Restore • 39
 Status • 22–27
 Test • 44–45
functions, system
 activation of • *See under* actions; outputs; sequences; smoke sensitivity levels. *See also* LED/switch modules
 disabling of • *See under* actions; laptop computers; mapping; messages; panel addresses; RS-485 channels; sequences; time controls; zones
 enabling of • *See under* actions; laptop computers; mapping; messages; panel addresses; RS-485 channels; sequences; time controls; zones
 restarting of • *See under* CPU; history reports; SLC
 restoration of • *See under* actions; outputs; sequences. *See also* LED/switch modules
 testing of • 44–45
 viewing of disabled • 25–27

G

generating reports • 40–43
Gnd1 indication • 23

H

head phones, SIGA-MDM • 52
history reports
 printing of • 43
 restarting of • 30

history reports (continued)
 viewing of • 42

I

indicators, audible • *See* buzzers
indicators, visual • *See* LCD; LEDs; VU meter
initiating a drill test • 21
instructions, operator
 emergency communications • 78
 fire alarm control panel • 78
issuing a page message • *See* Page to Alert switch, 2-MIC; Page to Evac switch, 2-MIC

J

jacks, SIGA-MDM • 52

K

keypad, 2-LCD • 12

L

laptop computers
 disabling of • 36
 enabling of • 33
LCD (liquid crystal display) messages
 2-CMDN(-C) • 57
 2-LCD • 14
 2-LSRA(-C) • 57
 2-SMDN(-C) • 57
LED/switch modules • 46–47
LEDs (light emitting diodes)
 2-CMDN(-C) • 58–59
 2-LCD • 10
 2-LSRA(-C) • 58–59
 2-MIC • 48
 2-SANCOM • 62
 2-SMDN(-C) • 58–59
 2-TEL • 50
 front panel • 46–47
 PT-1S • 73–75
 RSAN-PRT • 76
 SHO-4 • 67, 68–69
 SIGA-MDM • 51
 SLU-16 • 64
 SWU-8(/3) • 68–69
levels, password • 28
light emitting diodes • *See* LEDs
Lin1 indication • 23
liquid crystal display • *See* LCD messages
Local Silence switch • 10

M

maintenance messages • 19
making keypad entries • 12
Map1 indication • 23
mapping
 disabling of • 36
 enabling of • 33
master handset, 2-TEL • 50

menus

- Activate • 37–38
- Disable • 34–36
- Enable • 31–33
- Program • 28–30
- Reports • 40–43
- Restore • 39
- Status • 22–27

message queues • 16

message review switches, 2-LCD • 11

Message select switch, SIGA-MDM • 51

messages

- disabling of • 34
- enabling of • 31
- maintenance • 19
- priorities of • 16
- voice • 51–52
- waiting • 14

MIC/Line in, SIGA-MDM • 52

MIC/Line select switch, SIGA-MDM • 51

microphone module • *See* 2-MIC

monitor points • 19

Monitor switch • 11

Mpg1 indication • 23

MPw1 indication • 23

N

Normal LED, SIGA-MDM • 51

O

operating switches

- on LED/switch modules • 46–47
- on the 2-LCD • 10–11
- on the 2-LSRA(-C) • 57
- on the 2-MIC • 48–49
- on the 2-SANCOM • 63
- on the 2-SMDN(-C) • 57
- on the 2-TEL • 50
- on the **Error! Bookmark not defined.** • 76
- on the PT-1S • 74–75
- on the SAN-MIC II • 70
- on the SHO-4 • 68–69
- on the SIGA-MDM • 51
- on the SWU-8(/3) • 68–69

operator responses

- to fire alarms • 17
- to maintenance messages • 19
- to monitor points • 19
- to supervisory conditions • 17–18
- to trouble conditions • 18
- to verification messages • 20

outputs • 37, 39

P

Page to Alert switch, 2-MIC • 48

Page to Evac switch, 2-MIC • 48

panel addresses • 29

- disabling of • 35
- enabling of • 32

passwords, system • 28–29

Phone Call-In Silenced LED, 2-TEL • 50

Phone to Alert switch, 2-MIC • 48, 50

Phone to Evac switch, 2-MIC • 48, 50

Play LED, SIGA-MDM • 51

Play switch, SIGA-MDM • 51

Prg1 indication • 23

printer

- PT-1S • 73–75
- RSAN-PRT • 76

printing history reports • 43

printing sensitivity reports • 41

priorities, message • 16

privileges, password • 28

Prn1 indication • 23

Program switch • 13

programming system functions • *See* changing system passwords; programming the communications class; reconfiguring SLCs; setting the system date; setting the system time. *See also under* CPU; history reports; SLC

programming the communications class • 29

PT-1S • 73–75

Push-to-Talk switch, 2-MIC • 48

R

reading 2-CMDN(-C) messages • 60

reading 2-LCD messages • 14–15

reading 2-LSRA(-C) messages • 60

reading 2-SMDN(-C) messages • 60

reading LEDs

- on LED/switch modules • 46
- on the 2-CMDN(-C) • 58–59
- on the 2-LCD • 10
- on the 2-LSRA(-C) • 58–59
- on the 2-MIC • 48–49
- on the 2-SANCOM • 62
- on the 2-SMDN(-C) • 58–59
- on the 2-TEL • 50
- on the PT-1S • 74
- on the RSAN-PRT • 76
- on the SHO-4 • 68–69
- on the SIGA-MDM • 51
- on the SLU-16 • 64
- on the SWU-8(/3) • 68–69

reading the VU meters • 70–71

reconfiguring SLCs • 30

Record LED, SIGA-MDM • 51

Record switch, SIGA-MDM • 51

remote alphanumeric annunciators • *See* 2-CMDN(-C); 2-LSRA(-C); 2-SMDN(-C)

reports

- history • 42–43
- sensitivity • 40–41

Reports switch • 13

Res1 indication • 23

Reset switch • 10

resetting the panel after a fire alarm • 17

responses, operator

- to fire alarms • 17
- to maintenance messages • 19
- to monitor points • 19
- to supervisory conditions • 17–18

- responses, operator (continued)
 - to trouble conditions • 18
 - to verification messages • 20
- restarting system devices/functions • *See under* CPU;
 - history reports; SLC
- Restore switch • 13
- restoring system functions • *See under* actions; outputs;
 - sequences. *See also* LED/switch modules
- RS-485 channels
 - disabling of • 35
 - enabling of • 32
- RSAN-PRT • 76

S

- SAN annunciators • 61–71
- SAN-MIC II • 70–71
- scrolling message review switches • 11
- selecting system functions
 - on SAN annunciators • 68–69
 - on the 2-LCD • 13
- selecting voice messages • 51
- sensitivity reports • 40
- sequences
 - activation of • 37
 - disabling of • 35
 - enabling of • 32
 - restoration of • 39
- setting the SIGA-MDM signal level • *See* MIC/Line
 - select switch, SIGA-MDM
- setting the system date • 28
- setting the system time • 28
- SHO-4 • 67
- SIGA-MDM • 51–52
- Signature loop controller • *See* SLC
- Silence Call-In switch, 2-TEL • 50
- silencing buzzers
 - 2-CMDN(-C) • *See* trouble silence
 - 2-LCD • *See* local silence
 - 2-LSRA(-C) • *See* trouble silence
 - 2-SMDN(-C) • *See* trouble silence
 - 2-TEL • *See* Silence Call-In switch
- silencing NACs • *See under* alarm silence
- SLC (Signature Loop Controller)
 - reconfiguring of • 30
 - restarting of • 30
- SLU-16 • 64
- smoke sensitivity levels
 - activation of • 38
 - viewing of • 40–41
- SPw1 indication • 23
- starting the test function • 44
- Status • 13
- status screens, 2-LCD
 - disabled devices/functions • 25–27
 - field panel status • 24–25
 - general • 22–23
 - loop • 23–24
 - relay/LED • 25
- supervisory points • 17–18
- Supervisory switch • 11
- switch
 - user-defined • 11

- switches
 - 2-CMDN(-C) • 56
 - 2-LCD • 10–11, 13, 22–45
 - 2-LSRA(-C) • 56
 - 2-SANCOM • 63
 - 2-SMDN(-C) • 56
 - 2-TEL • 50
 - Activate • 37
 - Disable • 34
 - Drill • 21
 - Enable • 31
 - function • 13
 - message review • 11
 - Program • 28
 - PT-1S • 74
 - Reports • 40
 - Restore • 39
 - RSAN-PRT • 76
 - SAN-MIC II • 70
 - SHO-4 • 67, 68–69
 - SIGA-MDM • 51
 - Status • 22–27
 - SWU-8(/3) • 68–69
 - Test • 44
- SWU-8 • 65
- SWU-8/3 • 65–66

T

- telephone module • *See* 2-TEL
- test • *See* Humma Numma
- test function • 44, 45
- Test switch • 13
- testing system functions • 44–45
- time controls • 31, 34
- time, system • 14, 28
- trouble conditions • 18
- trouble silence • 56
- Trouble switch • 11

U

- User-defined switch • 11

V

- verification messages • 20
- viewing 2-LCD screens
 - on disabled device status • 25–27
 - on field panel status • 24–25
 - on general status • 22–23
 - on loop status • 23–24
 - on relay/LED status • 25
- voice messages • 51–52
- VU meter, SAN-MIC II • 70

Z

- zones • 31, 34